



RP6502/RP7502/RP8602  
Interactive Flat Panel  
User Manual



## Disclaimer

BenQ Corporation makes no representations or warranties, either expressed or implied, with respect to the contents of this document. BenQ Corporation reserves the right to revise this publication and to make changes from time to time in the contents thereof without obligation to notify any person of such revision or changes.

## Copyright

Copyright 2020 BenQ Corporation. All rights reserved. No part of this publication may be reproduced, transmitted, transcribed, stored in a retrieval system or translated into any language or computer language, in any form or by any means, electronic, mechanical, magnetic, optical, chemical, manual or otherwise, without the prior written permission of BenQ Corporation.

## Product support

This document aims to provide the most updated and accurate information to customers, and thus all contents may be modified from time to time without prior notice. Please visit the website for the latest version of this document and other product information. Available files vary by model.

1. Make sure your computer is connected to the Internet.
2. Visit the local website from [www.BenQ.com](http://www.BenQ.com). The website layout and content may vary by region/country.
  - User manual and related document: [www.BenQ.com](http://www.BenQ.com) > **Business** > **SUPPORT** > **Downloads** > model name > **User Manual**
  - (EU only) Dismantled information: Available on the user manual download page. This document is provided based on Regulation (EU) 2019/2021 to repair or recycle your product. Always contact the local customer service for servicing within the warranty period. If you wish to repair an out-of-warranty product, you are recommended to go to a qualified service personnel and obtain repair parts from BenQ to ensure compatibility. Do not disassemble the product unless you are aware of the consequences. If you cannot find the dismantled information on your product, contact the local customer service for assistance.

# Table of Contents

Product support.....	3
Safety warnings and precautions.....	6
Important safety instructions.....	7
Notes on this display .....	7
Notes on the LCD panel of this display .....	7
Safety notice for remote control .....	8
Battery safety notice .....	8
BenQ ecoFACTS .....	9
Package contents .....	10
Setting up the display .....	11
Mounting the display .....	11
Parts of the display and their functions .....	13
Front panel .....	13
Input/output terminals .....	15
Remote control .....	16
Using the remote control .....	17
Connection .....	19
Connecting the VGA input.....	19
Connecting the touch module.....	19
Connecting the digital inputs.....	20
Connecting the video output.....	21
Connecting to serial port.....	21
Connecting power .....	22
Basic operations.....	23
Turning the display on or off.....	23
Initial setup .....	24
OSD Setting .....	24
Switching input signals.....	28
Downloading software.....	28
Setting up the Internet connection.....	28
Updating software.....	31
Adjusting audio volume level.....	31

Important instructions for using the touch screen.....	36
<b>Menu operations</b> .....	<b>37</b>
One touch menu operation .....	37
Settings menu .....	37
System settings.....	45
<b>Android system interface</b> .....	<b>50</b>
Main interface .....	50
<b>APPS</b> .....	<b>60</b>
<b>BenQ Suggests</b> .....	60
<b>InstaShare</b> .....	61
<b>InstaQPrint</b> .....	62
<b>WPS Office</b> .....	63
<b>Email</b> .....	65
<b>Side Tool Bar</b> .....	66
<b>Blizz</b> .....	67
<b>Saffi</b> .....	68
<b>Product information</b> .....	<b>70</b>
Specifications .....	70
Dimensions (RP6502) .....	73
Dimensions (RP7502) .....	74
Dimensions (RP8602) .....	75
Supported input signal resolution.....	76
<b>Troubleshooting</b> .....	<b>77</b>
<b>Accessibility Requirements for Rehabilitation Act of 1973, Section 508</b> .....	<b>80</b>

# Safety warnings and precautions



The lightning flash with arrowhead symbol, within an equilateral triangle, is intended to alert the user to the presence of uninsulated “dangerous voltage” within the product’s enclosure that may be of sufficient magnitude to constitute a risk of electric shock to persons.



The exclamation point within an equilateral triangle is intended to alert the user to the presence of important operating and maintenance (servicing) instructions in the literature accompanying the appliance.



## THIS EQUIPMENT MUST BE GROUNDED

To ensure safe operation, the three-pin plug must be inserted only into a standard three-pin power outlet which is effectively grounded through normal household wiring. Extension cords used with the equipment must have three cores and be correctly wired to provide connection to the ground. Wrongly wired extension cords are a major cause of fatalities.

The fact that the equipment operates satisfactorily does not imply that the power outlet is grounded or that the installation is completely safe. For your safety, if you are in any doubt about the effective grounding of the power outlet, please consult a qualified electrician.

- The mains plug of the power supply cord shall remain readily operable. The AC receptacle (mains socket outlet) shall be installed near the equipment and shall be easily accessible. To completely disconnect this equipment from the AC mains, disconnect the power cord plug from the AC receptacle.
- Do not place this display on an uneven, sloping or unstable surface (such as a trolley) where it may fall and cause damage to itself or others.
- Do not place this display near water, like a spa or pool, or in a position which will allow the splashing or spraying of water onto the display, like in front of an open window where rain water may enter.
- Do not install this display in a confined space without proper ventilation and air circulation, such as in a closed cabinet. Allow proper space around the display for dissipating heat inside. Do not block any openings and vents on the display. Overheating may result in hazards and electric shock.
- Installation of this display should only be performed by a qualified technician. Failure to install this display properly may cause injuries and damages to the personnels and the display itself. Check the installation regularly and maintain the display periodically to ensure the best working condition.
- Use only the accessories approved or recommended by the manufacturer to mount this display. Using wrong or unsuitable accessories may cause the display to fall and result in serious personal injuries. Make sure that the surface and fixing points are strong enough to sustain the weight of the display.
- To reduce the risk of electric shock, do not remove covers. No user serviceable parts inside. Refer servicing to qualified service personnel.
- To prevent personal injuries, mounting the display is required before use.

## Important safety instructions

1. Read these instructions.
2. Keep these instructions.
3. Heed all warnings.
4. Follow all instructions.
5. Do not use this apparatus near water.
6. Clean only with dry cloth.
7. Do not block any ventilation openings. Install in accordance with the manufacturer's instructions.
8. Do not install near any heat sources such as radiators, heat registers, stoves, or other apparatus (including amplifiers) that produce heat.
9. Do not defeat the safety purpose of the polarized or grounding-type plug. A polarized plug has two blades with one wider than the other. A grounding-type plug has two blades and a third grounding prong. The wide blade or the third prong are provided for your safety. If the provided plug does not fit into your outlet, consult an electrician for replacement of the obsolete outlet.
10. Protect the power cord from being walked on or pinched particularly at plugs, convenience receptacles, and the point where they exit from the apparatus.
11. Only use attachments/accessories specified by the manufacturer.
12. Use only with the cart, stand, tripod, bracket, or table specified by the manufacturer, or sold with the apparatus. When a cart is used, use caution when moving the cart/apparatus combination to avoid injury from tip-over.
13. Unplug this apparatus during lightning storms or when unused for long periods of time.
14. Refer all servicing to qualified service personnel. Servicing is required when the apparatus has been damaged in any way, such as power-supply cord or plug is damaged, liquid has been spilled or objects have fallen into the apparatus, the apparatus has been exposed to rain or moisture, does not operate normally, or has been dropped.



## Notes on this display

- To prevent the risk of physical injuries, do not attempt to lift the display alone.
- Make sure you have four or more people available to help lift or a flat cart to transport the display to its final location.
- Keep the display horizontal as much as possible.
- Clear a floor space before unpacking.

## Notes on the LCD panel of this display

- The Liquid Crystal Display (LCD) panel of this display has a very thin protective layer of glass which is liable to marking or scratching, and cracking if struck or pressured. The liquid crystal substrate is also liable to damage under excessive force or extreme temperatures. Please handle with care.
- The response time and brightness of the LCD panel may vary with the ambient temperature.

- Avoid placing the display in direct sun or where direct sun or spot lighting will shine onto the LCD panel, as the heat may damage the panel and the external casing of the display, and the bright light will make viewing the display more difficult than necessary.
- The LCD panel consists of individual pixels to display images and is manufactured according to the design specifications. While 99.9% of these pixels work normally, 0.01% of the pixels may remain constantly lit (in red, blue or green) or unlit. This is a technical limitation of the LCD technology and is not a defect.
- LCD screens, like plasma (PDP) and conventional CRT (Cathode Ray Tube) screens, are also susceptible to 'screen burn-in' or 'image retention' which can be found on the screen as visible fixed lines and shades. To avoid such damage to the screen, avoid displaying still images (like On-Screen Display menus, TV station logos, fixed/inactive text or icons) for more than 30 minutes. Change the aspect ratio from time to time. Fill the entire screen with the image and eliminate the black bars whenever possible. Avoid displaying images in 16:9 aspect ratio over a long period of time, otherwise there may be visible burn marks on the screen as two vertical lines.  
Note: Under certain circumstances, condensation may occur on the inner side of the cover glass, it's a natural phenomenon and will not affect the operation of the display. This condensation will usually disappear after around 2 hours of normal operation.
- RP series does not offer image retention function, for more information, please refer to installation guide. If a still image is required for a display, it is recommended to enable **Pixel shift**. See [More settings on page 43](#) for more information.
- RP series does not support portrait use; portrait use may cause display damage. BenQ warranty will not cover faulty usage.

## Safety notice for remote control

- Do not put the remote control in the direct heat, humidity, and avoid fire.
- Do not drop the remote control.
- Do not expose the remote control to water or moisture. Failure to do so could result in malfunction.
- Confirm there is no object between the remote control and the remote sensor of the product.
- When the remote control will not be used for an extended period, remove the batteries.

## Battery safety notice

The use of the wrong type of batteries may cause chemical leaks or explosion. Please note the following:

- Always ensure that the batteries are inserted with the positive and negative terminals in the correct direction as shown in the battery compartment.
- Different types of batteries have different characteristics. Do not mix different types.
- Do not mix old and new batteries. Mixing old and new batteries will shorten battery life or cause chemical leaks from the old batteries.
- When batteries fail to function, replace them immediately.
- Chemicals which leak from batteries may cause skin irritation. If any chemical matter seeps out of the batteries, wipe it up immediately using a dry cloth, and replace the batteries as soon as possible.



- Due to varying storage conditions, the battery life for the batteries included with your product may be shortened. Replace them within 3 months or as soon as you can after initial use.
- There may be local restrictions on the disposal or recycling of batteries. Consult your local regulations or waste disposal provider.

## BenQ ecoFACTS

BenQ has been dedicated to the design and development of greener product as part of its aspiration to realize the ideal of the “Bringing Enjoyment 'N Quality to Life” corporate vision with the ultimate goal to achieve a low-carbon society. Besides meeting international regulatory requirement and standards pertaining to environmental management, BenQ has spared no efforts in pushing our initiatives further to incorporate life cycle design in the aspects of material selection, manufacturing, packaging, transportation, using and disposal of the products. BenQ ecoFACTS label lists key eco-friendly design highlights of each product, hoping to ensure that consumers make informed green choices at purchase. Check out BenQ's CSR Website at <http://csr.BenQ.com/> for more details on BenQ's environmental commitments and achievements.



## Package contents

Open the sales package and check the contents. If any item is missing or damaged, please contact your dealer immediately.

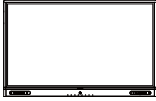

LCD display

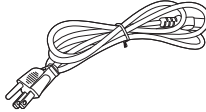

Power cord (By Region)

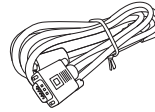

VGA cable x 1

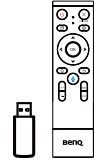

2.4GHz remote control

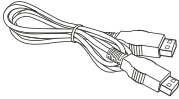

HDMI cable x 1

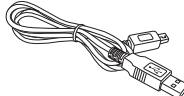

USB cable x 1

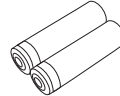

AAA battery x 2

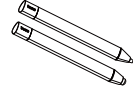

Touch pen x 2



Quick start guide

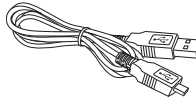

USB Type-C cable x 1



Wall mount x 1



- The type of power cord supplied may differ from that illustrated depending on your region of purchase.
- Before discarding the package, check that you haven't left any accessories inside the box.
- Dispose of packaging materials wisely. You can recycle the cardboard carton. Consider storing the package (if possible) for future transport of the display.
- Do not leave plastic bags within reach of young children or babies.

# Setting up the display

## Mounting the display

You can install the display on a vertical surface with a suitable wall mounting bracket. Please pay attention to the following notes during installation:

- This display should be installed by at least two adult persons. Attempting to install this display by only one person may result in danger and injuries.
- Refer the installation to qualified technicians. Improper installation may cause the display to fall or malfunction.

## Installing the display on a wall

1. Place a clean, dry and lint-free cloth on a flat, horizontal and object-free surface. Make sure that the size of the cloth is larger than the display.
2. Gently lay the display on the cloth with the LCD screen facing down.
3. Stability Hazard: The flat panel may fall, causing serious personal injury or death. To prevent injury, this flat panel must be securely attached to the wall in accordance with the installation instructions.

RP6502

\*Screw type: M8\*20L

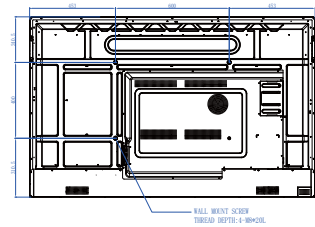

4. Identify the wall mounting screw holes on the back of the display as shown in the illustration.

RP7502

\*Screw type: M8\*20L

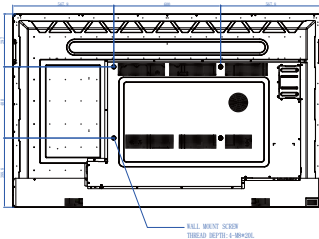

RP8602

\*Screw type: M8\*20L

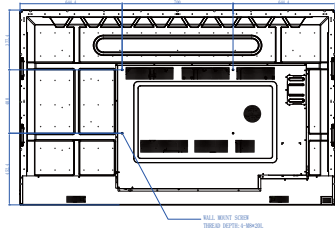

5. Install the wall mounting bracket on the display and attach the display to the wall according to the mounting bracket's instructions. The length of the screw should exceed the thickness of the wall mounting bracket by at least 25 mm. Make sure that all screws are tightened and secured properly. (Recommended torque: 470 - 635N•cm). The mounting means should be strong enough to bear the weight of the display.

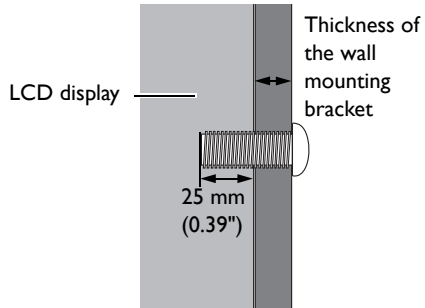

- To maintain proper ventilation, keep at least 10 mm of clear space from the back cover of the display to the wall.
- Please consult a professional technician for wall mount installations. The manufacturer accepts no liability for installations not performed by a professional technician.

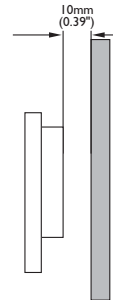

# Parts of the display and their functions

## Front panel

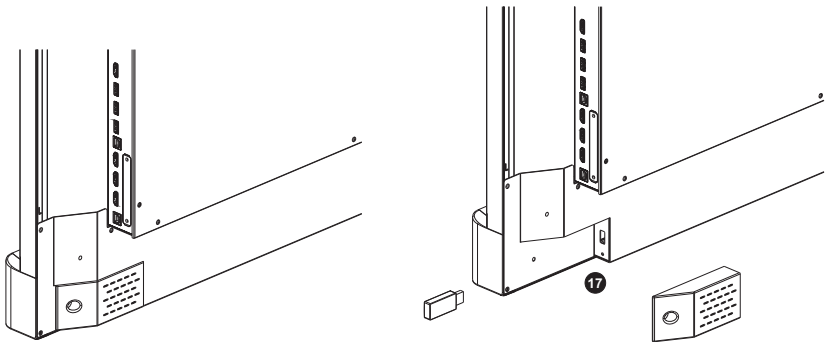
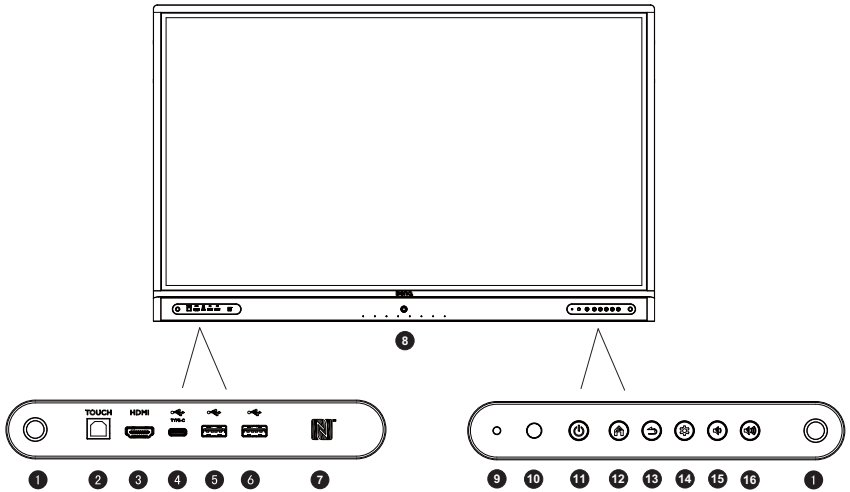

No.	Name	Description
1	<b>PIR sensor</b> (Short-range)	Short-range PIR sensor. Trigger the eye care protection mechanism when detecting human body near the display.

<b>2 TOUCH</b>	External computer touch signal input. When connecting external computer, besides connecting external computer VGA and audio signals, external computer's USB port needs to be connected to the corresponding group. Under the condition that driver is installed, external computer can be touch controlled through the equipment (touch function is effective in VGA and HDMI channel by default).
<b>3 HDMI</b>	High-definition multimedia interface signal input. Connect to PC with an HDMI output, a set-top-box, or other video devices capable of realizing touch function.
<b>4 TYPE-C</b>	USB Type-C. Connected with display, audio, touch, charge. Do not support data transfer.
<b>5 USB 3.0</b>	Connect USB devices such as USB keyboards, USB mice, and USB flash drives. OPS follow.
<b>6 USB 2.0</b>	Connect USB devices such as USB keyboards, USB mice, and USB flash drives. OPS follow.
<b>7 NFC Function</b>	NFC Sensor: NFC reader & writer.
<b>8 PIR sensor (Long-range)</b>	Long-range PIR sensor. Wake up the screen when detecting human body walking into the room.
<b>9 Ambient Light Sensor</b>	To detect if a source of light moves toward the sensor's range.
<b>10 IR Signal Receiver</b>	Receive IR signals. Do not obstruct the receiver.
<b>11 Power</b>	Tap to enter energy saving mode. Press and hold for 4 seconds or more to power off.
<b>12 Home</b>	Press to back to main screen.
<b>13 Return</b>	Press to return to previous level of menu.
<b>14 Menu</b>	Press to enter function menu.
<b>15 Volume Down</b>	Press to decrease volume.
<b>16 Volume Up</b>	Press to increase volume.
<b>17 USB 2.0/1.5A</b>	Unscrew the cover to access the USB slot for Wi-Fi dongle.

## Input/output terminals

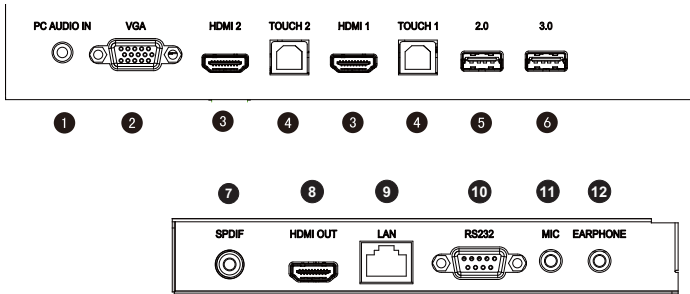

No.	Name	Description
1	PC AUDIO IN	Receive audio signals from an external device.
2	VGA	Receive analog RGB signals from an external device (such as a computer).
3	HDMI 1/HDMI 2	High-definition multimedia interface signal input. Connect to PC with an HDMI output, a set-top-box, or other video devices capable of realizing touch function.
4	TOUCH 1/ TOUCH 2	External computer touch signal input. When connecting external computer, besides connecting external computer VGA and audio signals, external computer's USB port needs to be connected to the corresponding group. Under the condition that driver is installed, external computer can be touch controlled through the equipment (touch function is effective in VGA and HDMI channel by default).
5	USB 2.0	Connect USB devices such as USB keyboards, USB mice, and USB flash drives.
6	USB 3.0	Connect USB devices such as USB keyboards, USB mice, and USB flash drives. OPS follow.
7	SPDIF	Connect the SPDIF cable from external devices to the display for audio out.
8	HDMI OUT	Connect to the display devices with an HDMI input.
9	LAN	10/100 LAN Mbps, connecting RJ45 terminals. This network port is only used for the closed Android OS on this product.
10	RS232	Serial interface, used for mutual transfer of data between devices.
11	MIC	Connect to a microphone.
12	EARPHONE	Connect to an earphone.



- USB2.0= 5V  $\equiv$  500mA / USB3.0= 5V  $\equiv$  900mA

- Type C= 5V  $\equiv$  2A

- OPS= 18V  $\equiv$  5A





- $\equiv$  : Direct Current / DC



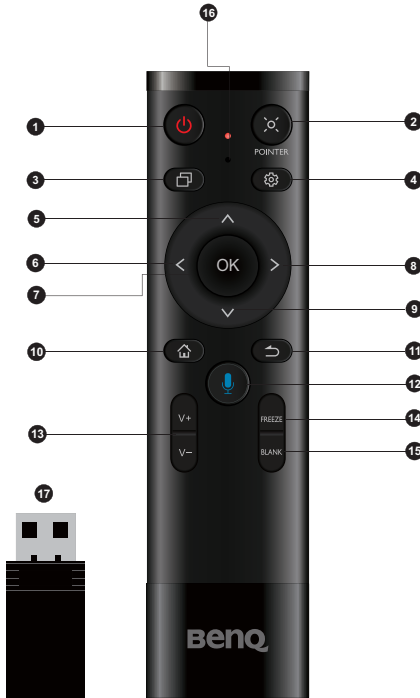









- $\sim$  : Alternating Current /AC

- The maximum length for the cables to be used with the USB slots are 5m (USB 2.0) and 3m (USB 3.0).

## Remote control



- 1**  Turn the display on or off.
- 2**  Pointer key. Press to activate the spotlight or pointer function and following the instruction on the screen.
- 3**  Press to open SwitchQ, a task switcher to switch between recent apps and input sources.
- 4**  Press to open or close the OSD menu.
- 5**  Direction key. Press for upward selection.

- 6**  Direction key. Press for left selection.
- 7**  Press to proceed.
- 8**  Direction key. Press for right selection.
- 9**  Direction key. Press for downward selection.
- 10**  Android system main screen button.
- 11**  Return key.
- 12**  Voice command key. Press to activate Saffi (BenQ Voice Assistant), hold the button for two seconds, then say the command you can use. Release the button until you finish the command.
  -  Speak directly to the microphone built into the top portion of the remote control. Position the microphone closer to your mouth or speak in a loud and clear voice.
- 13**  Volume up/down.
- 14**  Freeze screen.
- 15**  One key for blank screen.
- 16**  Microphone.
- 17**  The enclosed dongle to pair with the remote control. Read [Remote control important notice on page 17](#) for more information.



## Remote control important notice

1. This remote control applies only to a specific models and/or operating systems. Contact your reseller if any question.
2. The function keys can work only when the enclosed dongle is inserted to the BenQ IFFP.
3. The remote control and the enclosed dongle have been paired in default.

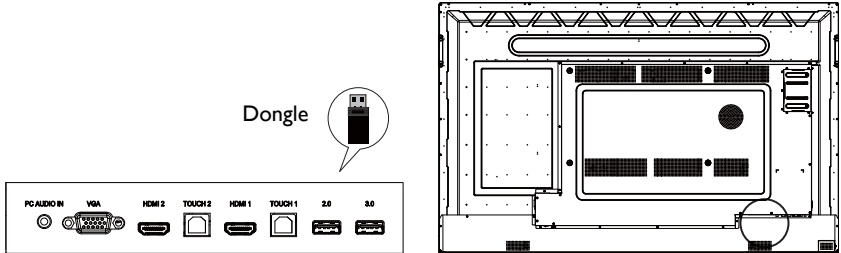

## Using the remote control

### Installing remote control batteries

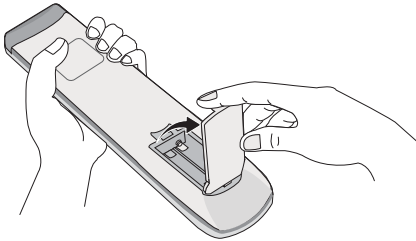

1. Open the remote control battery compartment cover.

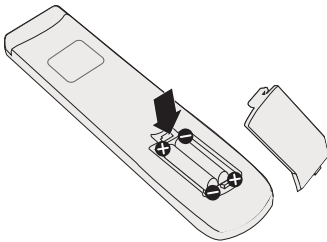

2. Insert the supplied batteries ensuring that the positive and negative marked battery terminals match the (+) and (-) marks in the battery compartment.



The supplied batteries are provided for your convenience so that you can operate the display straight away. You should replace them as soon as possible.

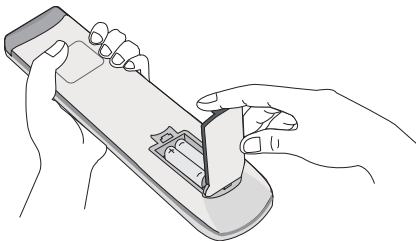

3. Refit the battery compartment cover.

## Using the BenQ IFP by remote control

1. Insert the enclosed dongle into BenQ IFP's USB port.
2. You can activate functions on the screen once the remote control is connected to its enclosed dongle as a receiver.
3. For detailed function of each button, please refer to [Remote control on page 16](#).

## Pairing the remote control and the enclosed dongle

If you are experiencing issues using the function key on the remote control, please follow the steps and pair again the remote control to resolve the issue:

1. Insert the enclosed dongle to IFP's USB port and place the remote control near it.
2. Press the **V-** and **BLANK** at the same time, and the indicator light starts flashing.
3. The pairing is completed once the indicator stops flashing.

## Remote control usage tips

- To power on/off the display, aim the top front of the remote control directly at the display's remote control sensor window when you press the buttons.
- Avoid getting the remote control wet or store it in humid environments (like bathrooms).
- If the display's remote control sensor window is exposed to direct sunlight or strong light, the remote control may not operate properly. In this situation, change the light source, readjust the angle of the display, or operate the remote control from a location closer to display's remote control sensor window.

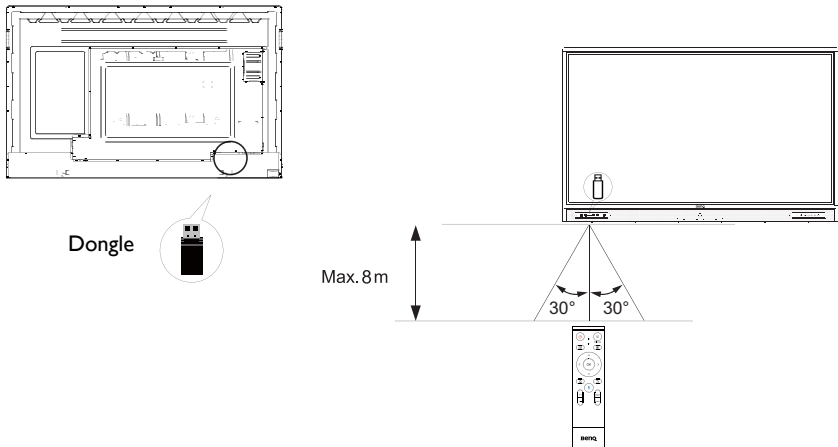

## Connection

### Connecting the VGA input

1. Connect the **VGA** jack on the display to the VGA output jack on a computer using a D-Sub (15-pin) cable.
2. Connect the computer's audio output jack to the **PC AUDIO IN** jack on the display with a suitable audio cable.

### Connecting the touch module

Connect the **TOUCH** jack on the display to the USB port of a computer using the supplied USB cable. The touch module of the display supports easy Plug-and-Play operation. There is no need to install additional drivers on the computer.

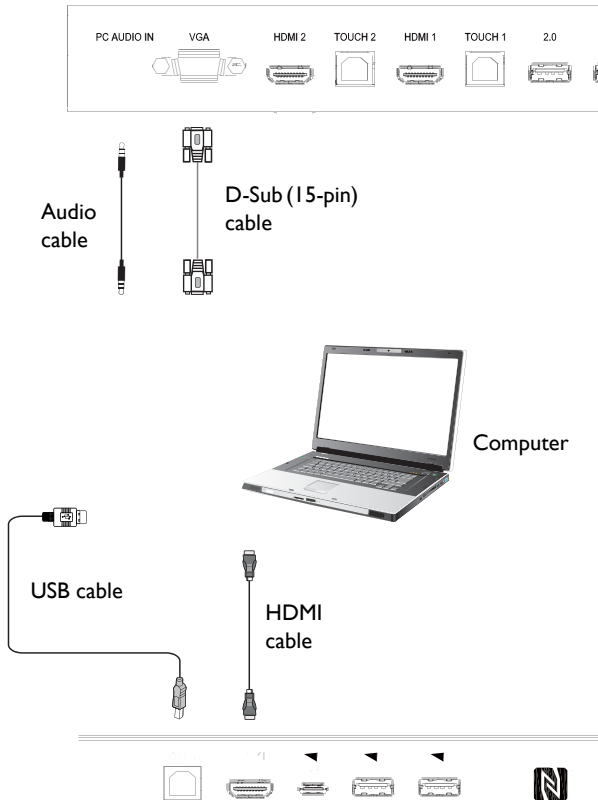

- Avoid blocking the touch screen frame (where sensors are located) when initiating the touch module.
- It is highly recommended that you connect the display to the PC or laptop directly. Avoid connecting the display to a face plate device which may cause failures in touch operations.
- If any ghost image occurs, please try to un-plug and then re-plug all USB cables. If the failure image still exists, use another USB type B to A cable.

## Connecting the digital inputs

1. Connect the HDMI output jack of a computer or A/V device (such as a VCR or DVD player) to the **HDMI** input jack on the display using an HDMI cable.
2. To view images from this input, press  on the remote control to switch to the respective input source.

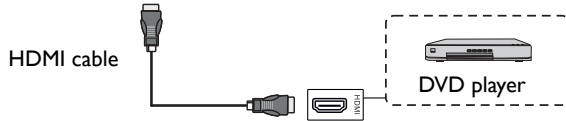
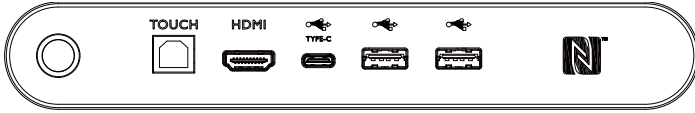

- The applicable cable is not supplied and should be purchased separately.
- The display provides a selection for the dual-monitor mode.

## Connecting the video output

For computer:

1. Use HDMI cable to connect from **HDMI OUT** to the respective jacks of the devices.
2. Plug in power cord, and switch power on.
3. Press  on the remote control to turn on the display.

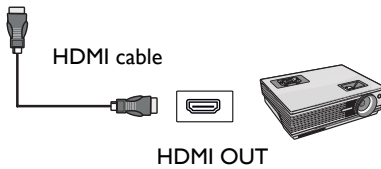
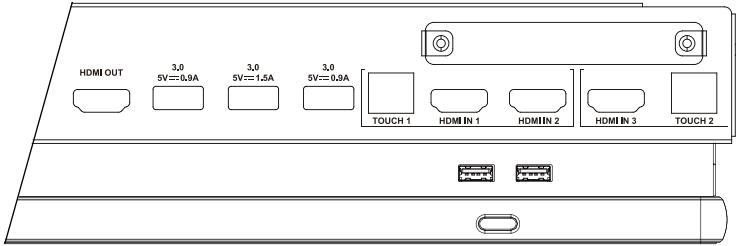

## Connecting to serial port

Directly connect the computer to **RS232** ports on the input/output terminals.

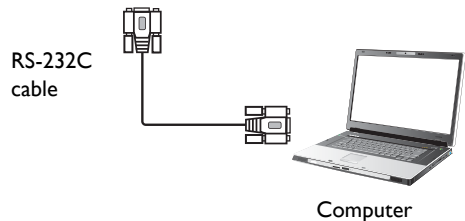
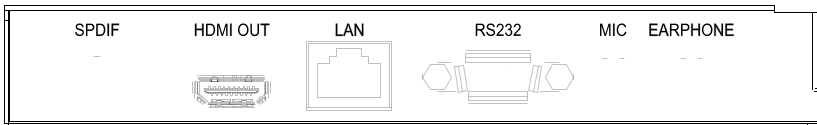

- The applicable cable is not supplied and should be purchased separately.
- This connection is applicable to straight-through RS-232C cable only.
- After using serial port line to connect central control equipment and machine, certain function of the machine can be controlled via central control equipment, such as: machine on/off, and adjustment of sound volume, etc.

## Connecting power

Plug one end of the power cord into the **Power** jack on the display and the other end into an appropriate power outlet (if the outlet is switched, turn on the switch).

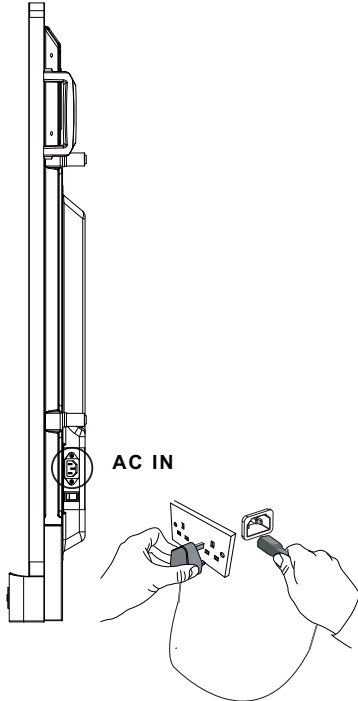

- The supplied power cord is suitable for use with 100-240V AC power only.
- The power cord and outlet illustrated may differ from the ones used in your region.
- Only use an appropriate power cord for your region. Never use a power cord which appears damaged or frayed, or change the plug type on the power cord.
- Be aware of the power loading when you use extension cords or multiple outlet power boards.
- There are no user serviceable parts in this display. Never unscrew or remove any covers. There are dangerous voltages inside the display. Turn off the power and unplug the power cord if you intend to move the display.
- The illustration is for your reference only.

## Basic operations

### Turning the display on or off

1. Be sure to follow the instruction of [Connecting power on page 22](#).
2. Before turning on the display, make sure the Power switch is set to **ON**. The system will enter standby mode.

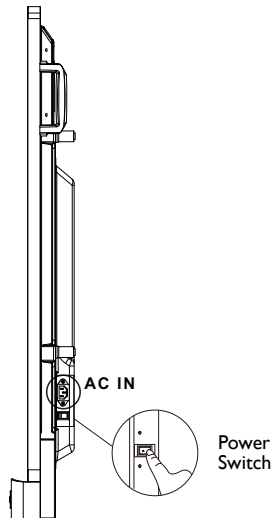

- To turn on the display, press the **Power** button on the control panel or on the remote control.
- To turn off the display, press the **Power** button on the control panel or on the remote control. The system will automatically enter standby mode.

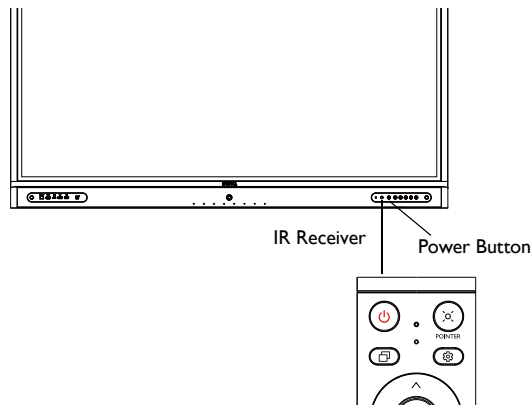

The display's standby mode still consumes power. To completely cut off power supply, set the Power switch to OFF (O) and then disconnect the power cord from the power outlet.

## Initial setup

After you have connected the display to the power, you are ready to power on the display. The first time you power on the display, you will be guided through a series of setup screens. Follow the on-screen instructions or the steps below to start up your display and complete the initial setup.

1. Turn on the display. Wait for the display to boot up with the BenQ screen. This may take a moment.
2. Tap **Next** on the screen to begin. Follow the on-screen instructions to set up the language, date and time, and network. Or you can skip some of these steps and complete the setup later.

## OSD Setting

Under **Connection**, you can select a desired input source and adjust backlight. Refer to [Input settings on page 37](#) for more information.

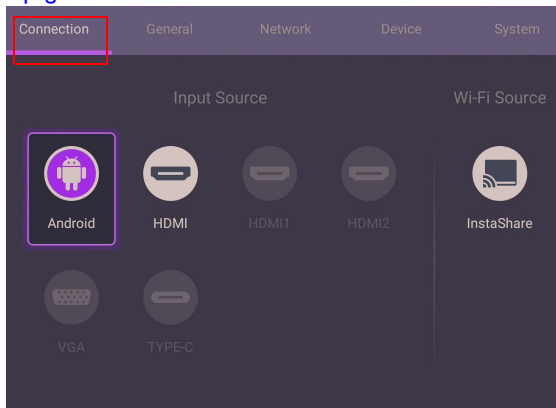



## Account Information

Three types of accounts are provided: Guest, Admin, and Multiple users.

### Guest

It's for public use under Guest account. You are able to change the headshot, wallpaper, volume and brightness.

### Admin

Log in as Admin. Under **Personal settings**, you can change the headshot, wallpaper, and password. You can also enable **AMS service**, set **Available offline accounts**, and check **Device information**.

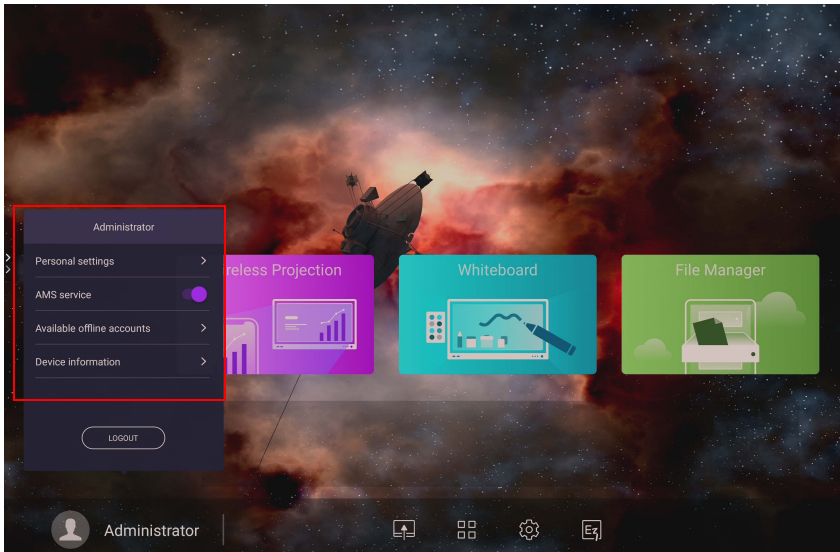

### Multiple users

To access your personal account, you have to ask the administrator to activate AMS service first and create your account through **IAM** service. Refer to [User Management on page 26](#) for more information.

## User Management

To add a new user, please contact your IT manager to create your account through BENQ IAM web service.

### Creating a new account

1. As an administrator to create a new account for regular users, go to BenQ Service website: <https://ams.benq.com>. Suggested browsers are Chrome, Firefox.
2. Log in and choose **IAM**.

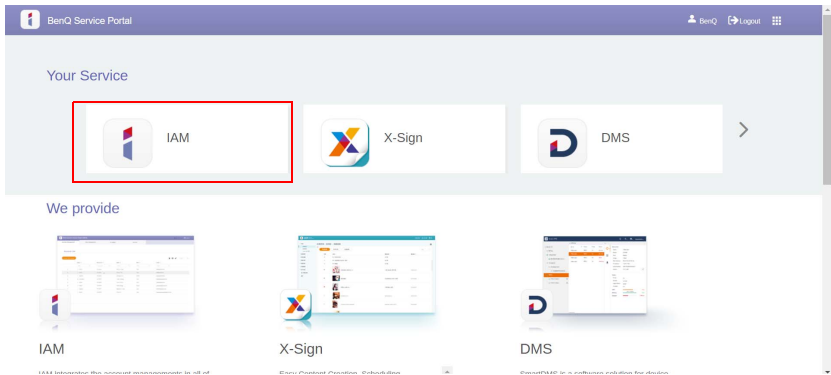

3. Click **Create New Account to continue.**

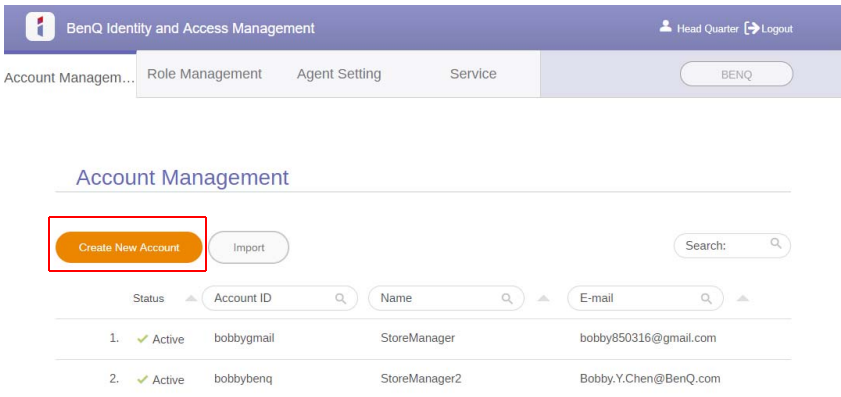

4. Fill in the following fields. Be sure to enter the correct email address and activate the X-Sign and Broadcast service. Click **Submit** to create a new account.

BenQ Identity and Access Management

Account Management Role Management Agent Setting Service

### Create New Account

E-mail

Use email as account ID

Account ID

REMARK: Please do NOT using your personal data to fill the account name. It may increase the risk to reveal you privacy.

Password

Confirm Password

Name

Company BenQ

Country/Area Taiwan

Timezone (UTC+08:00 Taipei)

Note within 150 characters

Service Setting

Set this account as substitute administrator, has all of the permissions, two accounts at most

Enable Service	Role	Action
<input checked="" type="checkbox"/>	X-Sign Schedule Manager	Create a new role
<input type="checkbox"/>	DMS Guest	Create a new role
<input type="checkbox"/>	AMS User	Create a new role
<input checked="" type="checkbox"/>	Broadcast	

**Submit** Cancel



You can easily switch to different services, **X-Sign**, **DMS**, **AMS**, **Broadcast**, by clicking the icon on the upper right corner.

5. The account has been created and a verifying email is sent to the new account owner.

Message ×

The account has been created. We'll send the email from "BenQ". If it isn't in your inbox, check your folders. If a spam filter or email rule moved the email, it might be in the Spam, Junk, Trash, Deleted items, or Archive folder.

**Close**

## Switching input signals

To select an input signal, do either one of the following:

- Press  on the remote control.
- Press the **Menu** button on the front panel.
- Drag the **OSD** menu up from the bottom-center of the screen.

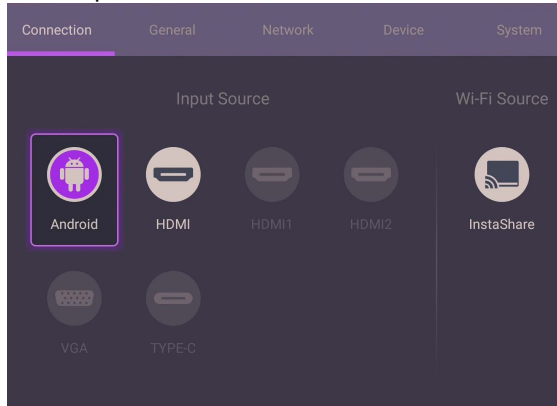

## Downloading software

BenQ may periodically release software updates that may add functions or applications associated with your display. To check if there is a software update available for your device or to obtain the software license key, please visit <https://business-display.benq.com/en/findproduct/signage/software/partner-software/download.html>. Then enter the serial number (can be found on the sticker attached on the back of the display) and click **OK** to access the Software download page.

## Setting up the Internet connection

Your display must be connected to a network to conduct OTA updates or surf the Internet.



To find the MAC address in Android OS, please go to **Setting > System > About > Status**.

## Network setting

On the home screen, go to **Setting > System > About > Status**. If there is no IP address shown, please connect the display to the ethernet cable.

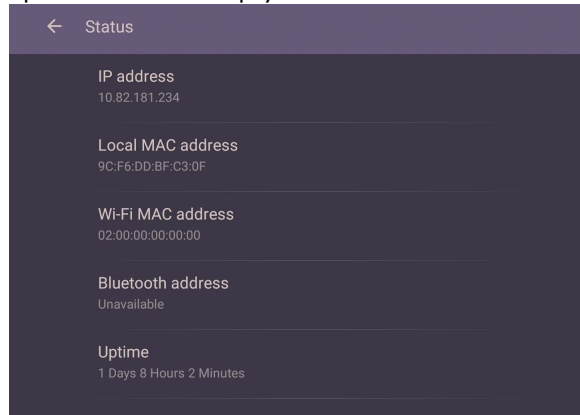

## Wireless connection

You must use a wireless adapter in order to connect the display to the Internet wirelessly. Please contact your local dealer for more information on configuring the wireless connection.

1. Press  on the remote control, or go to **Network > Wi-Fi**.

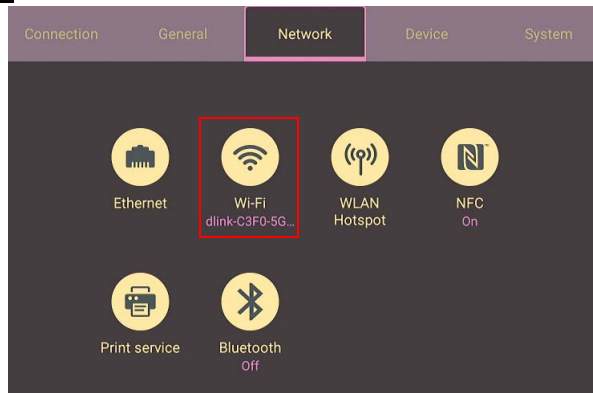

2. Insert the Wi-Fi dongle and the switcher will automatically change to **ON**. A list of available networks will show on the screen.

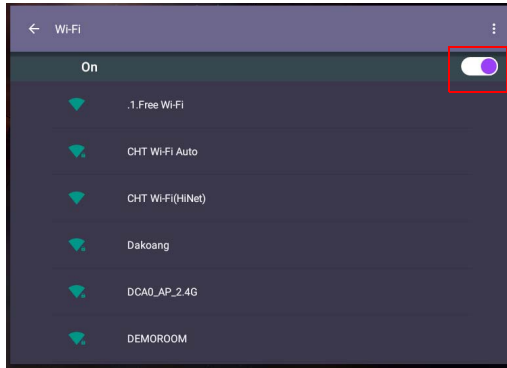

3. Touch the network's name to connect to the network. The password is needed if it is your first time to use the network. Key in the password and press **Connect**. The device is now connected to the **WLAN**.



- If you are connecting to a secured wireless network, enter the password for the wireless network access when prompted and tap **Connect**.
  - For wireless connection, BenQ shipment does not include wireless dongles, therefore, you may purchase it separately via the local dealer.
-

## Updating software

Whenever a new version of software is available, the system will automatically detect the update and will prompt you to download it every time you turn on the display. If you want to update the software, choose **NETWORK UPDATE** or **USB UPDATE** to continue the update. Or you can skip this step and update the software later.

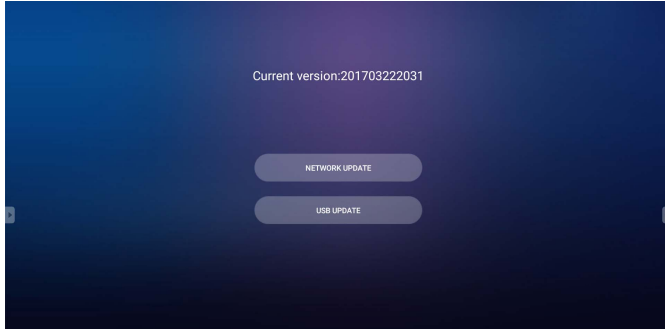

To manually update the software:

1. Go to **System > About > System updates**.

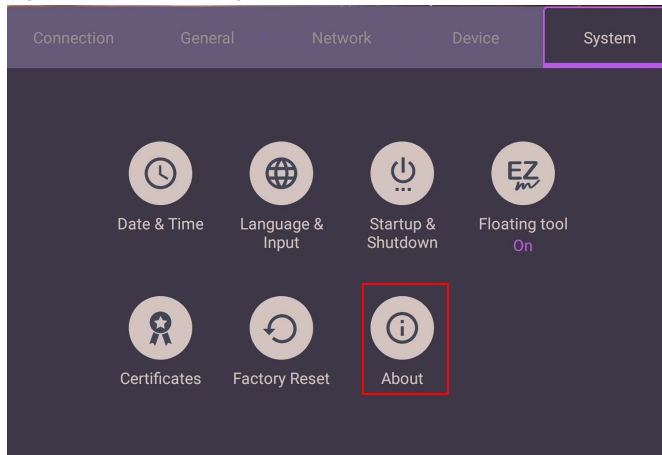



2. If there is an update available, the system will begin updating.



- Software update process may take some time to complete.
- During the update process, do not turn off the device or disconnect the Internet connection. Any interruptions during the software update process may permanently damage your display.

## Adjusting audio volume level

To adjust the audio volume level do either one of the following:

- Press **V+** / **V-** on the remote control to adjust the volume.
- Press  /  on the front panel of the display.
- Go to **Setting > General** to adjust the volume. Refer to [General settings on page 38](#) for more information.

## Using the touch screen



You can use the optical touch screen to control your operating system. The touch screen can emulate basic mouse functions and supports multi-touch functions for Windows 10/8/7/XP, Mac OS 10.11~10.14, Chrome OS 58, and Android. The following table shows a list of gestures you can use on the touch screen.

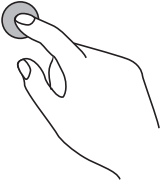
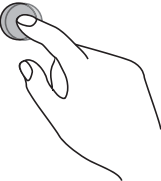
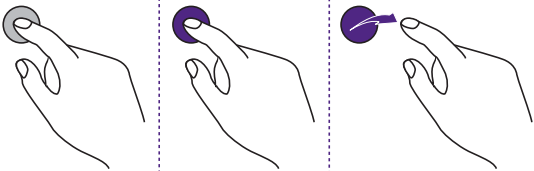
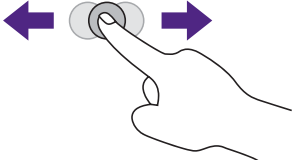

- Ensure that you have installed the USB cable on the display to a computer.
- Windows is a registered trademark of Microsoft Corporation in the United States and other countries.

OS functions	Gesture actions
For Windows XP, Windows 7, Windows 8, and Windows 10	
Click	Tap the screen once. 
Double-click	Tap the screen twice. 
Right-click	<ol style="list-style-type: none"> <li>1. Press on the target.</li> <li>2. Hold and wait for a blue ring to appear.</li> <li>3. Release your finger.</li> </ol> 
Drag	Drag one finger left or right. 

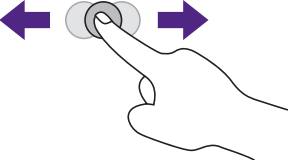
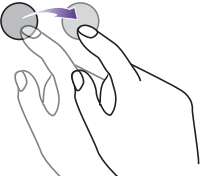

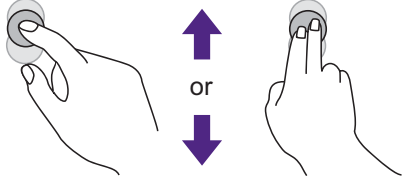
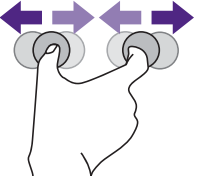
OS functions	Gesture actions
For Windows 7, Windows 8, and Windows 10	
Selection	<p>Drag one finger left or right.</p> 
Pan up / Pan down / Back / Forward	<p>Quickly drag your finger (Flick) in a desired direction.</p> 
Multi-touch functions	
For Windows 7 - Home Premium, Professional, Enterprise and Ultimate versions	
Right-click	<ol style="list-style-type: none"> <li>1. Press on the target.</li> <li>2. Tap the screen with another finger.</li> <li>3. Release the second finger.</li> </ol> 
Scrolling	<p>Drag one or two fingers up or down.</p> 
Zoom	<p>Move two fingers apart or toward each other.</p> 

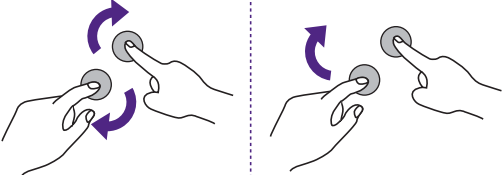
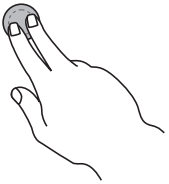
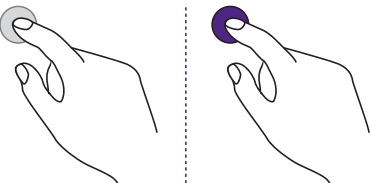
OS functions	Gesture actions
Supported by specific applications	<ul style="list-style-type: none"> <li>• Move two fingers in opposing directions.</li> <li>• Use one finger to pivot around another.</li> </ul> 
Supported by specific applications	<p>Tap two fingers simultaneously. The target should be the midpoint between the fingers.</p> 
For Windows XP and Windows 7	
Wakeup from Windows sleep mode (S3)	<p>Press and hold for 4 seconds.</p> 

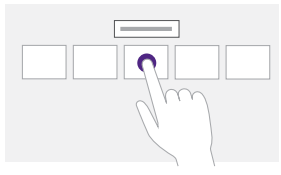
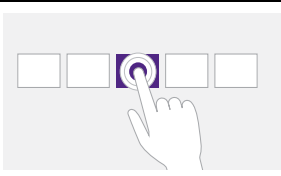
Gesture	Description
For Windows 8	
	<p>Press and hold to learn</p> <p>This touch interaction causes detailed information or teaching visuals (for example, a tooltip or context menu) to be displayed without a commitment to an action. Anything displayed this way should not prevent users from panning if they begin sliding their finger.</p>
	<p>Tap for primary action</p> <p>Tapping on an element invokes its primary action, for instance launching an application or executing a command.</p>

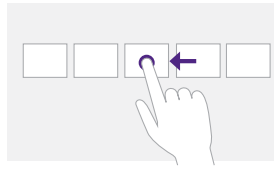
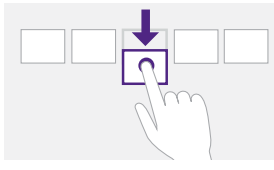
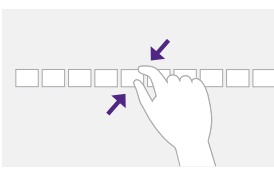
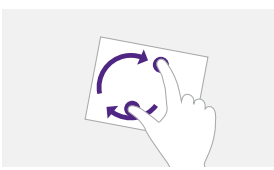
Gesture	Description
 A hand is shown sliding its index finger from right to left across a row of five square buttons. A purple arrow points to the left, indicating the direction of the slide.	<p><b>Slide to pan</b></p> <p>Slide is primarily used for panning interactions but can also be used for moving, drawing or writing. Slide can also be used to target small, densely packed elements by scrubbing (sliding the finger over related objects such as radio buttons).</p>
 A hand is shown swiping its index finger downwards over a square button. A purple arrow points downwards, indicating the direction of the swipe.	<p><b>Swipe to select, command, and move</b></p> <p>Sliding the finger a short distance, perpendicular to the panning direction, selects objects in a list or grid (ListView and GridLayout controls). Display the AppBar with relevant commands when objects are selected.</p>
 A hand is shown pinching and stretching its index and middle fingers over a horizontal row of ten square buttons. Purple arrows indicate the inward and outward movements of the fingers.	<p><b>Pinch and stretch to zoom</b></p> <p>While the pinch and stretch gestures are commonly used for resizing, they also enable jumping to the beginning, end, or anywhere within content with Semantic Zoom. A SemanticZoom control provides a zoomed out view for showing groups of items and quick ways to dive back into them.</p>
 A hand is shown turning its index and middle fingers around a square button. Purple curved arrows indicate the circular motion of the fingers.	<p><b>Turn to rotate</b></p> <p>Rotating with two or more fingers causes an object to rotate.</p>

## Important instructions for using the touch screen

Please clean the frame when there is sign of malfunction on the touch screen.

- Before you clean the screen, make sure the display is turned off, and unplug the power cord.
- Remove dust or dirt from the screen and the infrared plastic filter periodically. It is suggested using a small amount of alcohol to clean the infrared plastic filter.
- To avoid damage to the screen, never use any type of abrasive materials to wipe the screen.
- Use a neutral detergent to clean the touch screen. Avoid using detergents with erosive substance, such as banana oil or ammonia.
- Moisten a clean soft, lint-free cloth with a neutral detergent and then clean the touch screen.
- Do not spray a detergent on the screen surface or the body directly. It may result in a short circuit to the touch screen.
- Keep the touch screen out of direct sunlight or spotlights.

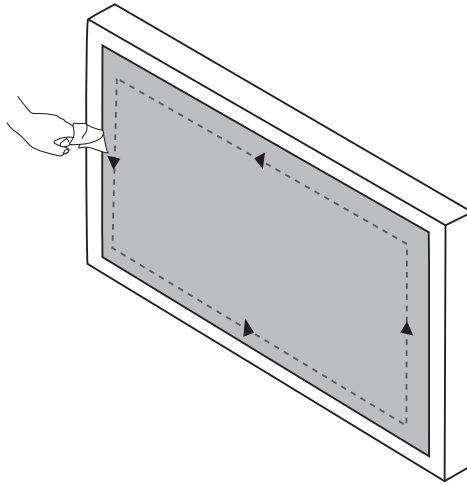

# Menu operations

## One touch menu operation

Drag the **OSD** menu up from the bottom-center of the screen, as shown below, to enter the **OSD** menu.

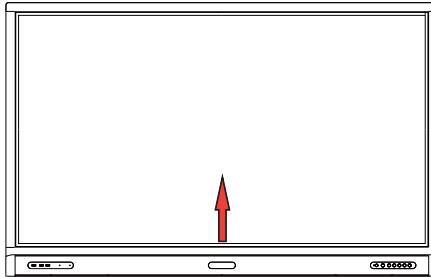



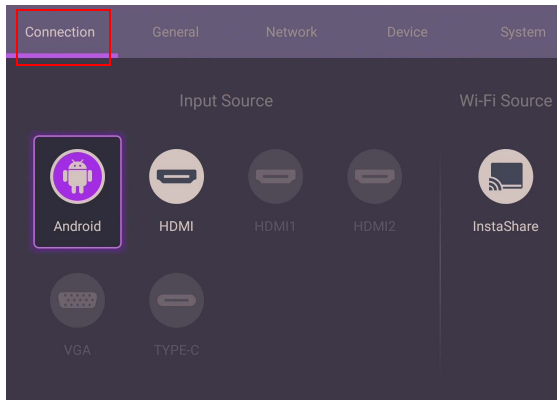

## Settings menu

### Input settings

Press  on the remote control, **Menu** on the front panel, or drag from the bottom middle to the center of the screen to enter the **OSD** menu.



- Press  /  /  /  on the remote control and press **OK** to confirm, or directly click a desired input source.
- Press  on the remote control or click a blank area outside the menu to exit the menu.

## General settings

Go to **General** to access the **Audio** and **Picture** settings.

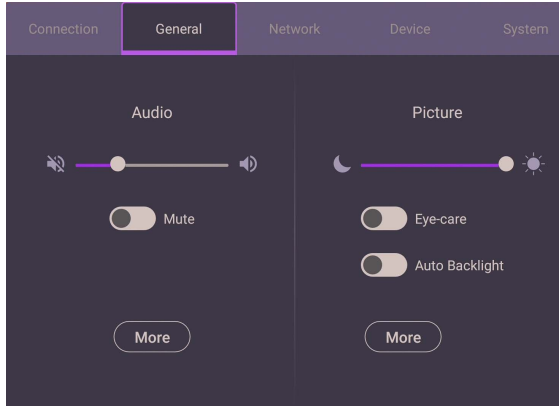

### Audio

- Under **Audio**, Use the volume bar to adjust the volume for the display.
- Directly swipe  to enable or disable **Mute**.
- Go to **More** to enter **Audio** menu.

### Picture

- Under **Picture**, use the brightness bar to adjust the brightness for the display.
- You can enable the **Eye-Care** function on the OSD menu. **Eye-Care** switches the display's low blue light mode and activates the flicker free function.
- Directly swipe  to enable or disable **Auto Backlight**.
- Go to **More** to enter **Picture** menu.

## Eye-Care solutions

Blue light with wavelengths under 455 nm could affect vision and age the eyes. **Eye-Care** solution is designed for eyesight protection: the display provides proprietary eye-care technology with zero-flicker performance and ultra-low blue light emission, preventing eyestrain, eye fatigue and macular degeneration caused by extended sessions in front of a display. In addition, advanced anti-glare screen treatment minimizes distracting reflections and glare for optimal productivity and comfort.



Suggestions for long-term use of the display:

- Rest your eyes for 10 minutes after 30 minutes of continuous use.
- For every 20 minutes of display viewing, look into the distance for 20 seconds.
- When your eyes get sore and strained, close your eyes for a minute and then roll your eyes in all directions.

To activate the smart eye care solution:

- Enable the Eye Care function under **General**.
- Go to **Device > Display > Eye care option**.

Menu	Description
Standard	Set as default value once <b>Eye-Care</b> function is enabled.
On-body detection	Activate the PIR motion sensor to detect human body and trigger the eye care protection mechanism.
Auto brightness	Panel backlight will be adjusted automatically according to the ambient light.

Low blue light & Flicker Free:

- To accord with Low blue light TUV certificated, the default setting is **Picture Mode: Standard, Brightness: 50, Contrast: 50, and Color Temperature: Standard**, and then enable **Eye-Care** function.
- To accord with Flicker Free TUV certificated, the default setting is **Picture Mode: Standard, Brightness: 50, Contrast: 50, and Color Temperature: Standard**.



For more information about Picture settings, refer to [Picture settings on page 41](#).

## PIR Sensor (Motion Sensor)

- You can enable the **PIR Sensor** function on the OSD menu. **PIR Sensor** allows you to sense motion, often used to detect if a human has moved in or out of the sensor's range.
- The display automatically turns on **Eye-Care** and dims the brightness of the screen when a human is walking in front of the sensor.



The performance of **PIR Sensor** would be limited by the environment and objects around.

• Audio settings

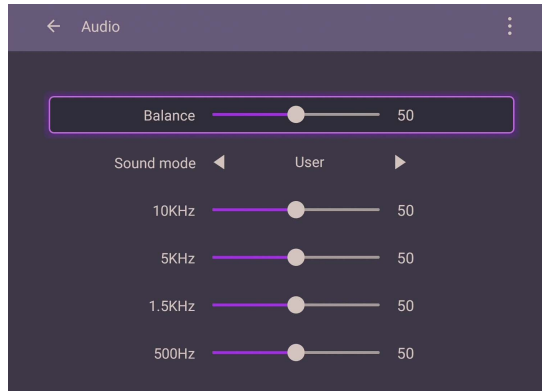
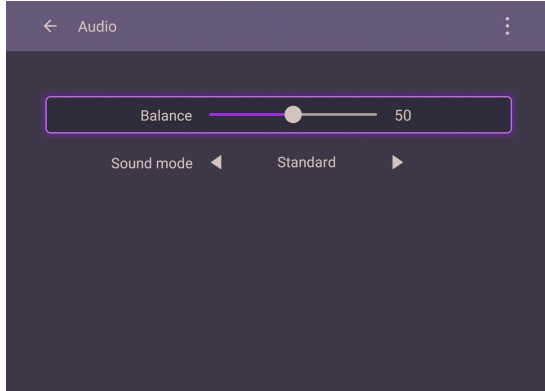

- Press **▲/▼/◀/▶** on the remote control and press **OK** to confirm or directly click an item.
- Press **⏪** on the remote control or click a blank area outside the menu to exit the menu.

Menu	Description
<b>Balance</b>	Drag the knob to adjust the balance.
<b>Sound Mode</b>	<ul style="list-style-type: none"> <li>• Touch a preset sound environment. Options are <b>Standard</b>, <b>News</b>, <b>Music</b>, <b>Movie</b>, <b>Sport</b>, or <b>User</b> mode.</li> <li>• Under <b>User</b> mode, you can adjust 10KHz, 5KHz, 1.5KHz, 500Hz.</li> </ul>



## Picture settings

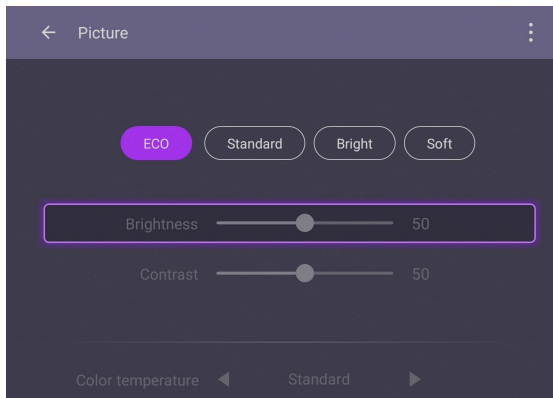
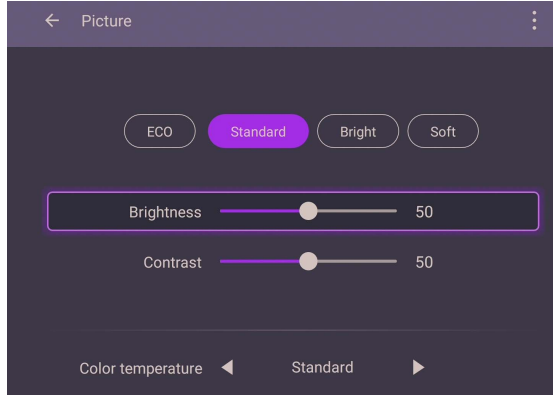

- Press **▲/▼/◀/▶** on the remote control and press **OK** to confirm or directly click an item.
- Press **⏪** on the remote control or click a blank area outside the menu to exit the menu.

Menu	Description
<b>Picture Mode</b>	<ul style="list-style-type: none"> <li>• Press <b>▲/▼/◀/▶</b> on the remote control or click a picture mode. Options are <b>Eco</b>, <b>Standard</b>, <b>Bright</b>, and <b>Soft</b>.</li> <li>• Under <b>Eco</b> mode, <b>Brightness level</b>, <b>Contrast</b>, and <b>Color Temperature</b> are locked.</li> </ul>
<b>Brightness level</b>	Under <b>Standard</b> , <b>Bright</b> , and <b>Soft</b> mode, press <b>◀/▶</b> on the remote control or drag the knob to adjust the brightness.
<b>Contrast</b>	Under <b>Standard</b> , <b>Bright</b> , and <b>Soft</b> mode, press <b>◀/▶</b> on the remote control or drag the knob to adjust the contrast.
<b>Color Temperature</b>	Press <b>▲/▼/◀/▶</b> on the remote control or click a preset color temperature for the image. Options are <b>Standard</b> , <b>Cool</b> or <b>Warm</b> .

## Screen settings

Go to **Device > Screen** to access the **Screen** settings.

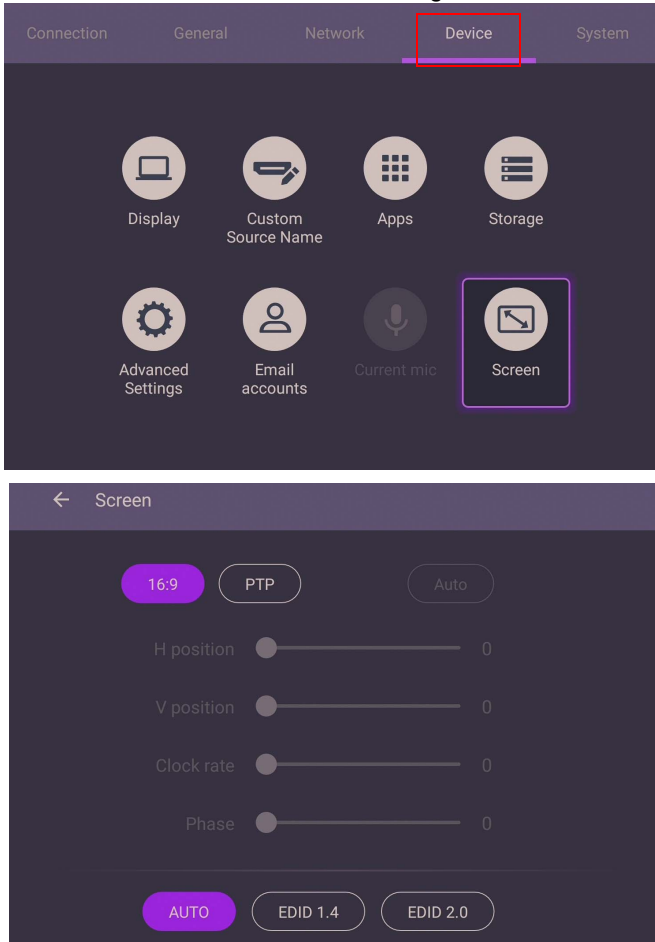

- Press **▲/▼/◀/▶** on the remote control and press **OK** to confirm or directly click an item.
- Press **⏪** on the remote control or click a blank area outside the menu to exit the menu.
- Press **◀/▶** on the remote control and press **OK** to adjust image.

Menu	Description
<b>Aspect ratio</b>	Press <b>◀/▶</b> on the remote control or click an aspect ratio. Options are <b>16:9</b> or <b>PTP</b> . You can also select <b>Auto</b> to adjust the image.

- The display automatically enters energy saving mode when no one is detected within the sensor's range.
- The display automatically turns off when no one is detected within the sensor's range for a long period of time.
- Use the **H Position**, **V Position**, **Clock rate**, and **Phase** functions to manually adjust the image.





Menu	Description
<b>H Position</b>	Press to move the screen to the left or right.
<b>V Position</b>	Press <b>OK</b> on the remote control or click the switch to lock or unlock the remote control IR sensor on the front panel of the display.

## More settings

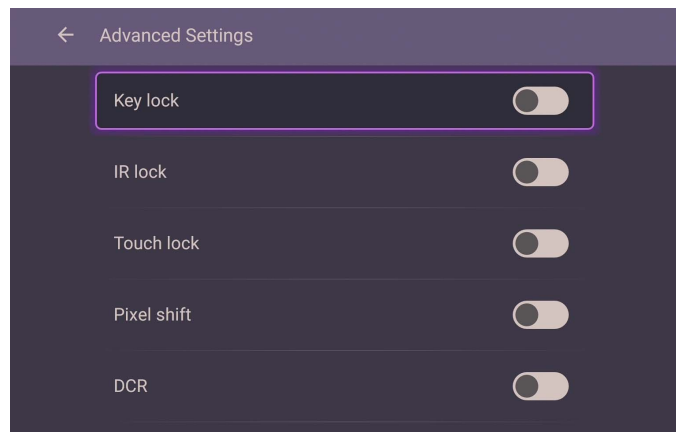
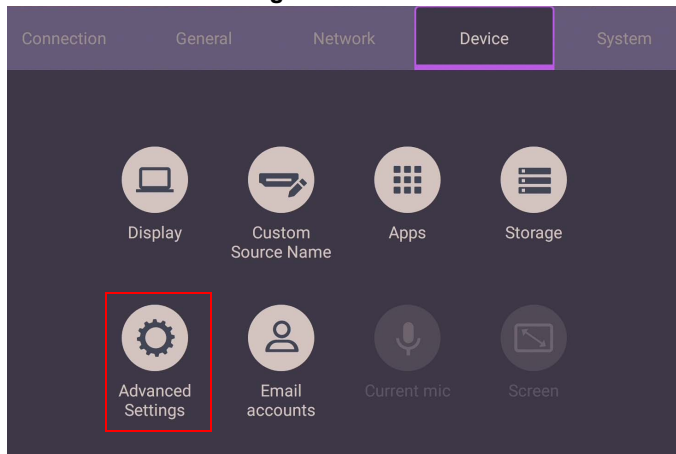
### Advanced settings

Go to **Device > Advanced settings**.



- Press  /  /  /  on the remote control and press **OK** to confirm or directly click an item.
- Press  on the remote control or click a blank area outside the menu to exit the menu.

Menu	Description
<b>Key lock</b>	Press <b>OK</b> on the remote control or click the switch to lock or unlock the buttons on the front panel of the display.
<b>IR lock</b>	Press <b>OK</b> on the remote control or click the switch to lock or unlock the remote control IR sensor on the front panel of the display.
<b>Touch lock</b>	Press <b>OK</b> on the remote control or click the switch to lock or unlock the screen.
<b>Pixel shift</b>	Press <b>OK</b> on the remote control or click the icon to set a pixel shift preventing from image retention.
<b>DCR</b>	Press <b>OK</b> on the remote control to enable or disable <b>DCR</b> .



- If keypad, IR and touch are locked all at once, please follow the steps to unlock: Press  on the remote control for five seconds.
- For image retention, please see [Notes on the LCD panel of this display on page 7](#) for more information.

## System settings

On the home screen, select **Setting > System** to enter system settings.

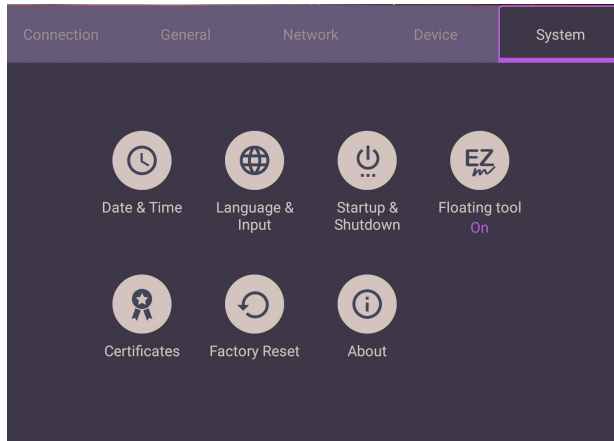

- Press  on the remote control or click a blank area outside the menu to exit the menu.

Options	Description
<b>Date &amp; time</b>	Click to set date, time, and their formats in Android.
<b>Language &amp; input</b>	Click to set <b>Language, Keyboard &amp; Input methods</b> in Android.
<b>Startup &amp; Shutdown</b>	Click to set the <b>Startup channel, OPS startup option, Wake on Lan,</b> and <b>Power off reminder</b> . Refer to <a href="#">Startup &amp; Shutdown on page 47</a> for more information.
<b>Floating tool</b>	Click to open and close the floating tool. Refer to <a href="#">Floating Annotation Toolbar on page 51</a> for more information.
<b>About</b>	Click to view system information in Android.



The amount of available storage space for the user varies according to the amount of pre-installed apps and images occupying the total storage space.

## Proxy setting

- Go to **Network > Ethernet**.

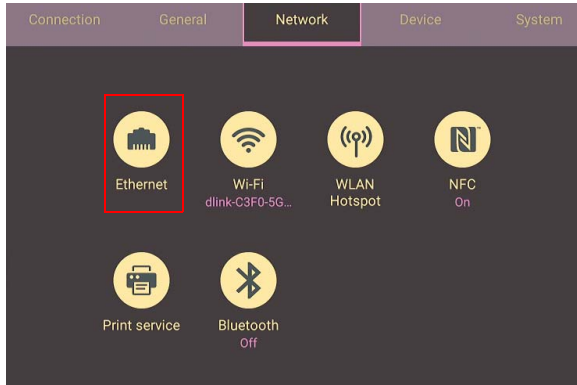

- Press **Proxy** to go to the proxy setting.

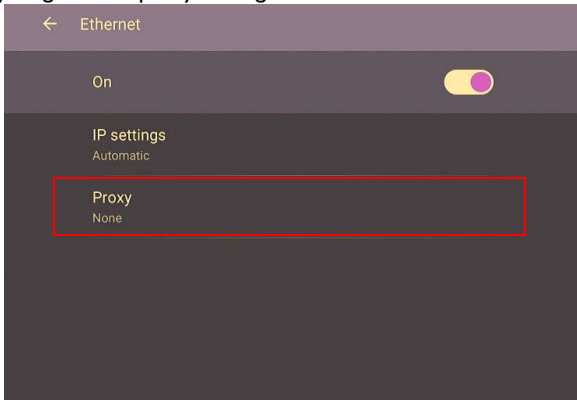

- Enter the proxy host name.
- Enter the using channel.

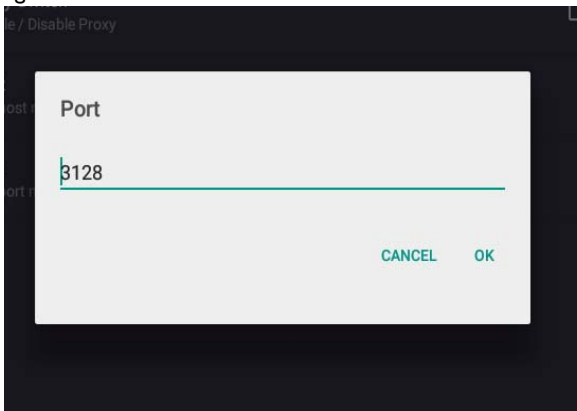

## Startup & Shutdown

- Go to **System > Startup & Shutdown**.

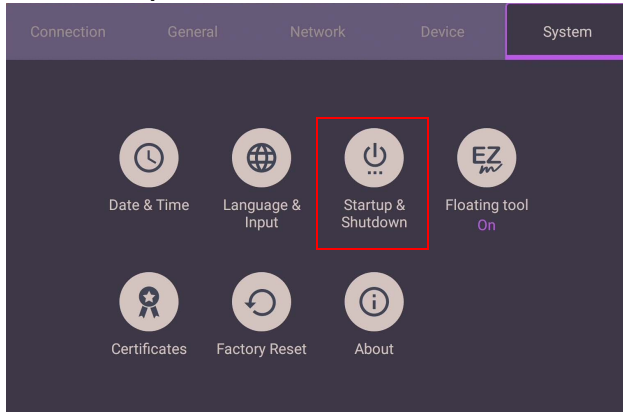

- For **Startup source**, you can choose **Last channel** or other sources.

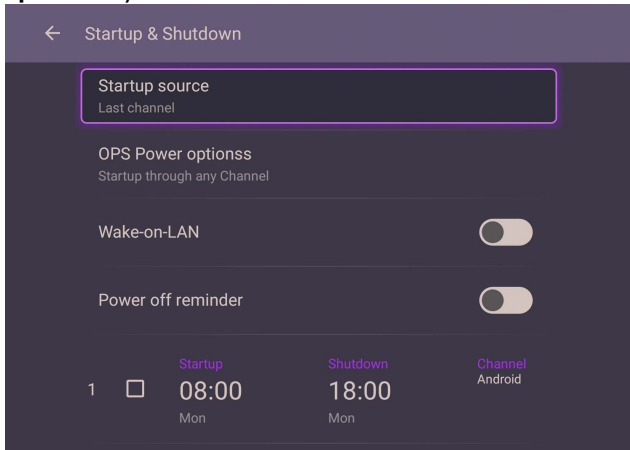

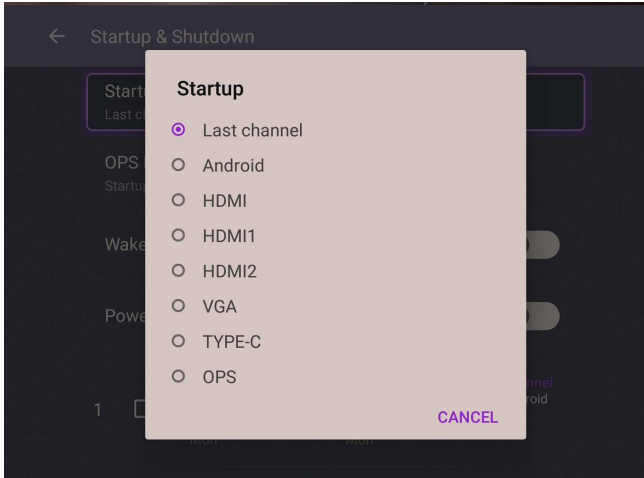

- For **Built-in OPS startup option**, you can choose **Startup only through OPS built-in startup option** or **startup through any channel**.

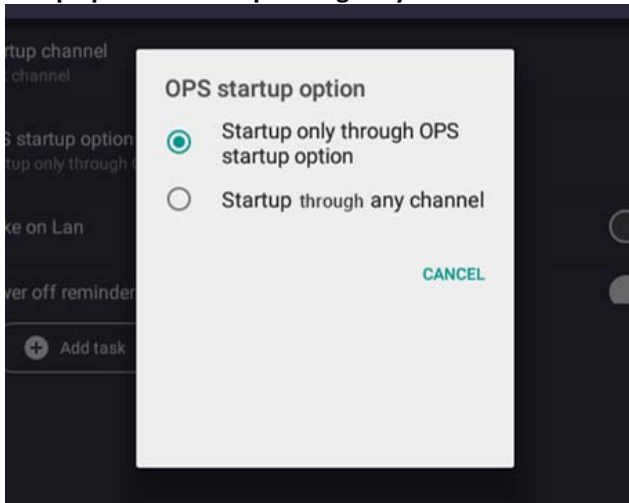



- For **Power off reminder**, you can set on or off time. Schedules can be made by choosing the days of the week.

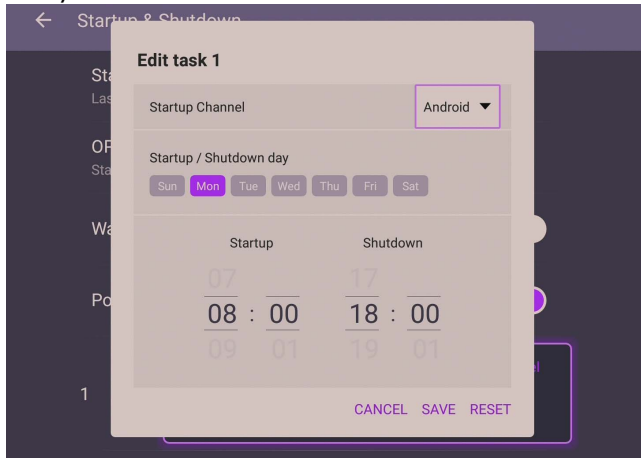

# Android system interface





Note that this is a closed Android OS. Download and use of unauthorized apps on this system are not available.

## Main interface

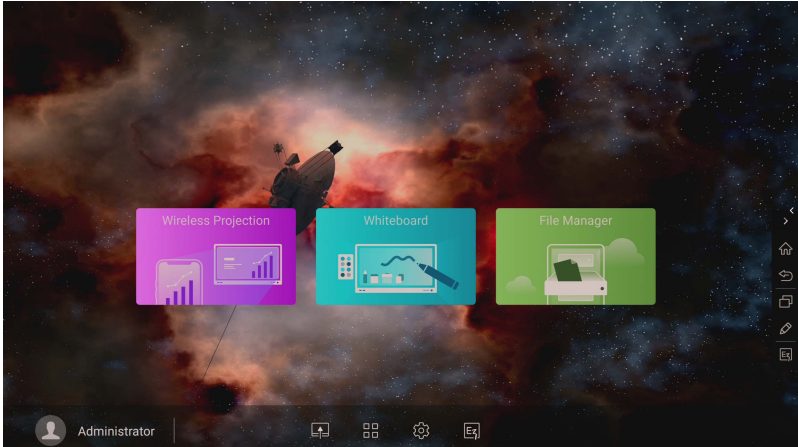
The display launches the Android main interface by default.



To navigate the Android main interface:

- Press  on the remote control or **Home** button on the front panel to return to the main interface.
- Press  on the remote control or drag the **OSD** menu up from the bottom-center of the screen to enter the **OSD** menu to select an input.

## Floating Annotation Toolbar

The Floating Annotation Toolbar is a convenient function that allows you to quickly write or create annotations on any screen that the display is showing. Under any input source or in the Android interface, touch and hold two fingers spaced about 20 – 50 mm apart on the screen for more than two seconds to launch the Floating Annotation Toolbar menu as shown below.

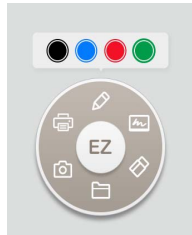

Icon	Function	Description
	Close and Move	Long press this button to drag and move the Floating Annotation Toolbar around. You can also click the button to close the floating toolbar and clear all the brushes.
	Annotate	Click to switch the color of the brush. Color options are blue, red, green, and black. Palm eraser is provided for you to erase any contents on the display just with your palm while you are writing without switching to Eraser.
	Whiteboard	Click to start <b>EZWrite 5.0</b> .
	Clear All	Click to erase all annotations on the screen. You may also quickly erase any annotations made by wiping any writing or drawings on the touchscreen using a balled-up fist.
	File Folder	Click to open the most recent file folder.
	Screenshot	Click to take a screenshot of the screen.
	Recording	Click to start recording the screen.

## CO2 Sensor

The concentration value of CO2 sensor may vary depending on the environment such as temperature, humidity, and placement (by windows or under air conditioning). This means that the CO2 sensor will always accurately measure the increments between ppm levels, but the baseline of the measurement may shift over time.

It is normal if the concentration value is slightly higher or lower than its original calibration.

The CO2 sensor has a self-correction mechanism to make the sensor more in line with the current installation environment, so that the value can be more accurate.

If your IFP device is not used or stored for a long time, please calibrate before using the CO2 sensor. To start the calibration, follow the directions.

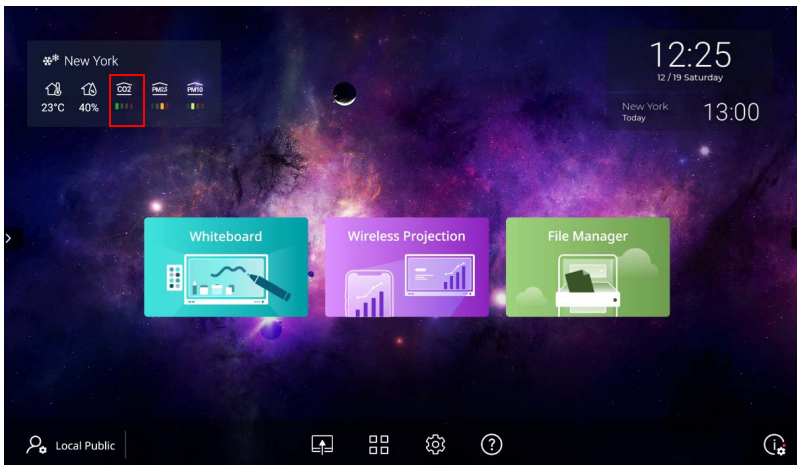

### Auto calibration

To provide correction for the optimal CO2 concentration for the current environment, the calibration mechanism will collect the CO2 concentration value for 25 consecutive hours to meet the temperature and humidity of the current space.

During the automatic calibration, do not interrupt or turn off the power supply. Do not move the IFP and make sure that the device is in an environment with good ventilation, to ensure a better calibration result.

## AMS file manager overview

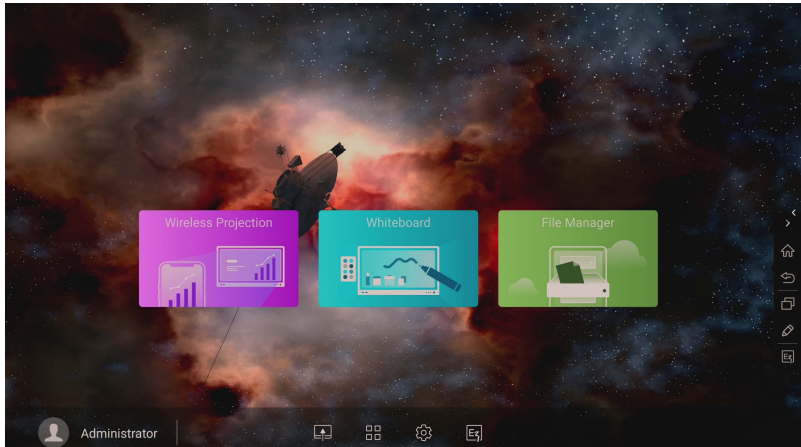

- Tap  to launch **AMS**. With this application, you can access your personalized workspace environment and settings and manage your files and accounts on any IFP that you have logged into.

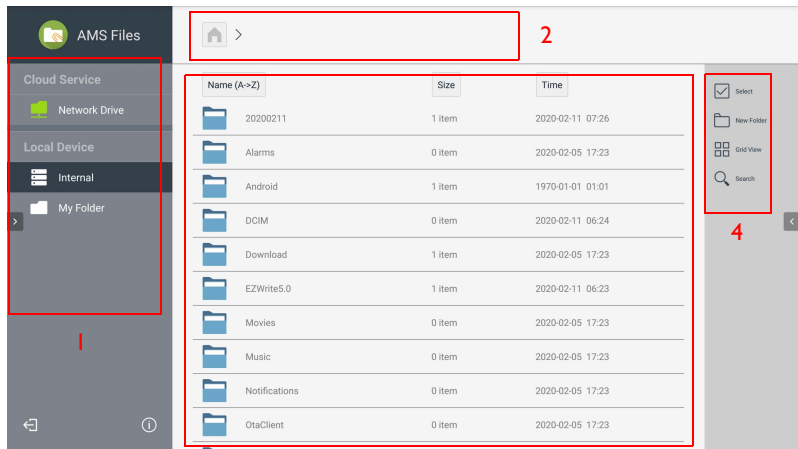

- While logging in, you will see four main parts, as described in the table below:



3

Item	Description
1. Source Selection	<ul style="list-style-type: none"> <li>You can open files from the cloud storage services like Google Drive, Dropbox, or Samba.</li> <li>You can also open files from the local devices like <b>Internal, My Folder</b>, or connected USBs.</li> </ul> <p> The icon  next to Google Drive, Dropbox shows that the account is bound to AMS service.</p>
2. Folder Path	You can browse the file folder in this area.
3. Listing Files	You can see a list of files from the storage device you select.
4. Operating Tab	You can edit the files using the operating tabs here.



Regular users can only view their own files, while the local admin can view all users' files in the domain.





## Multimedia files



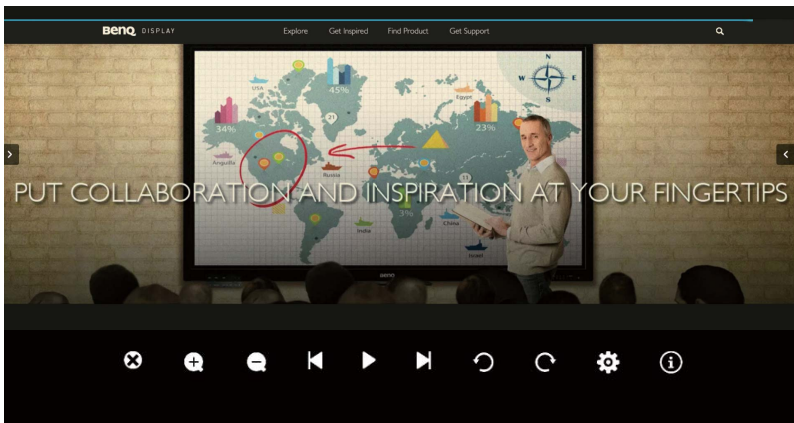



Multimedia files such as images, audio files, and videos can be played by directly tapping on the file icon.

### Image

Select an image file you want to show on the display and perform any of the functions shown on the screen.



Icon	Function
	Close the current image file.
	Magnify the current image.
	Shrink the current image.
	Play the previous image.

	Play/pause the current playback.
	Play the next image.
	Rotate the current image counter-clockwise.
	Rotate the current image clockwise.
	Go to the settings.
	See the information about the file name, creation time, file size, and the file format.





### Supported image format (maximum resolution)

File	Image	Supported range
.bmp	BMP	Max Resolution: 8000 × 8000
		Min Resolution: 4 × 4
.gif	GIF	Max Resolution: 8000 × 8000
		Min Resolution: 4 × 4
.jpeg/.jpg	JPEG/JPG	Max Resolution: 8000 × 8000
		Min Resolution: 4 × 4
.png	PNG	Max Resolution: 8000 × 8000
		Min Resolution: 4 × 4

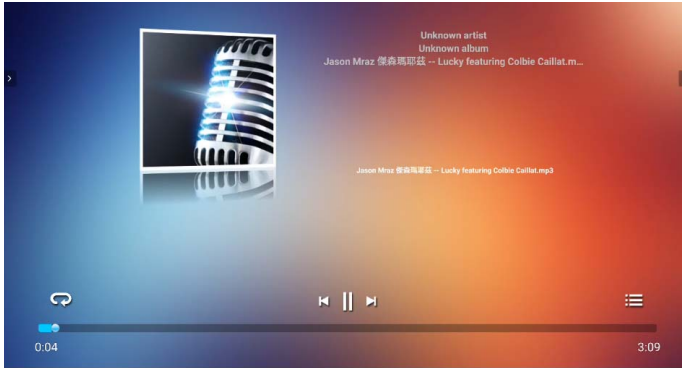
## Audio

Select an audio file you want to play and perform any of the functions shown on the screen.



Icon	Function
	Repeatedly play audio files in the playlist.
	Play the previous audio file.
	Play/pause the current audio file.
	Play the next audio file.
	Check the audio information.

### Supported audio format (Codec)

File	Format	Audio Codec	Supported range
.aac	AAC	AAC	Sample Rate: 8K~96KHz
			Bit Rate: 24K~576Kbps
.ape	Monkey's Audio	Monkey's Audio	Sample Rate: Max 48KHz
			Bit Rate: max 1411Kbps
.flac	FLAC	FLAC	Sample Rate: Max 192KHz
			Bit Rate: max 1411Kbps
.m4a	ALAC	ALAC	Sample Rate: 8K~96KHz
			Bit Rate: 24K~576Kbps





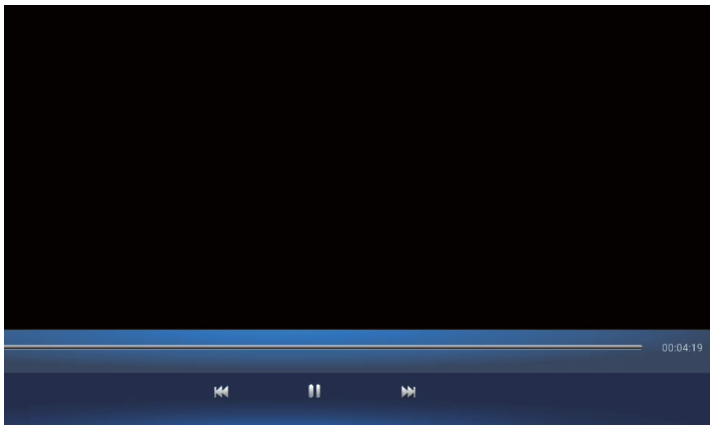

File	Format	Audio Codec	Supported range
.mp3	MPEG Audio Layer3	MPEG1/2 layer3	Sample Rate: 8K~48KHz
			Bit Rate: 32K~320Kbps
.ogg	Vorbis	Vorbis	Sample Rate: 8K~48KHz
			Bit Rate: max 256Kbps
.wav	WAV	LPCM	Sample Rate: 8K~192KHz
			Bit Rate: max 320Kbps

## Video

Select a video file you want to play on the display and perform any of the functions shown on the screen.



Icon	Function
	Adjust the video volume.
	Play the previous video file.
	Play/pause the current video file.
	Play the next audio file.

**Supported video format (Codec) Up to 4K resolution**

File	Codec		
Extensions	Video	Audio	Maximum transmit ratio
.3g2	H.263	AAC, AMR_NB	1920*1088 30 Fps, 5Mbps
.3gp	H.264		3840*2160 30 Fps, 160Mbps
	H.263		1920*1088 30 Fps, 5Mbps
	MPEG-4		1920*1088 30 Fps, 50Mbps
.avi	H.263	MPEG1/2 Layer3, AAC, LPCM	1920*1088 30 Fps, 5Mbps
	H.264		3840*2160 30 Fps, 160Mbps
	Mpge-1		1920*1088 30 Fps, 80Mbps
	MPEG-2		1920*1088 30 Fps, 80Mbps
	MPEG-4		1920*1088 30 Fps, 50Mbps
	MJPEG		1920*1080 30 Fps, 150Mbps
.flv	H.263	MPEG1/2 Layer3, AAC	1920*1088 30 Fps, 5Mbps
	VP6		1920*1088 30 Fps, 40Mbps
	H.264		3840*2160 30 Fps, 160Mbps
.f4v	H.264	AAC	3840*2160 30 Fps, 160Mbps
.mkv	H.264	AAC, MPEG1/2 Layer3	3840*2160 30 Fps, 160Mbps
	H.265		3840*2160 60 Fps, 160Mbps
	Vc-1		1920*1088 30 Fps, 45Mbps
.mov	H.264	AAC, PCM	3840*2160 30 Fps, 160Mbps
	H.265		3840*2160 60 Fps, 160Mbps
	MPEG-4		1920*1088 30 Fps, 50Mbps
	MJPEG		1920*1080 30 Fps, 150Mbps
.mp4	H.264	AAC	3840*2160 30 Fps, 160Mbps
	H.265		3840*2160 60 Fps, 160Mbps
	MPEG-4		1920*1088 30 Fps, 50Mbps

File	Codec		
Extensions	Video	Audio	Maximum transmit ratio
.VOB	MPEG-2	MPEG1/2	1920*1088 30 Fps, 80Mbps
.mpg/.MPEG	H.264	MPEG1/2 Layer3, AAC	3840*2160 30 Fps, 160Mbps
	MPEG-1		1920*1088 30 Fps, 80Mbps
	MPEG-2		1920*1088 30 Fps, 80Mbps
.ts	H.264	AAC AAC, MPEG1/2 Layer3	3840*2160 30 Fps, 160Mbps
	H.265		3840*2160 60 Fps, 160Mbps
	MPEG-2		1920*1088 30 Fps, 80Mbps
	MPEG-4		1920*1088 30 Fps, 50Mbps
	VC-1 (AP)		1920*1088 30 Fps, 45Mbps

# APPS

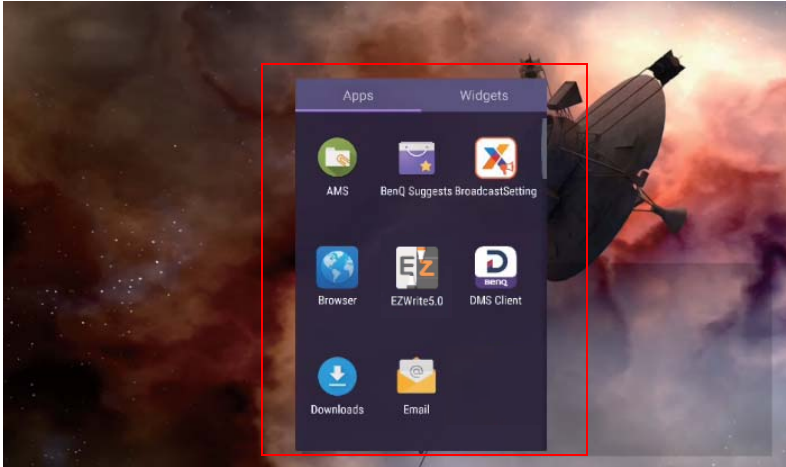

Tap the desired app to launch the app.

## BenQ Suggests

Tap  to launch **BenQ Suggests**. With this application, you can view apps suggested by BenQ for download.

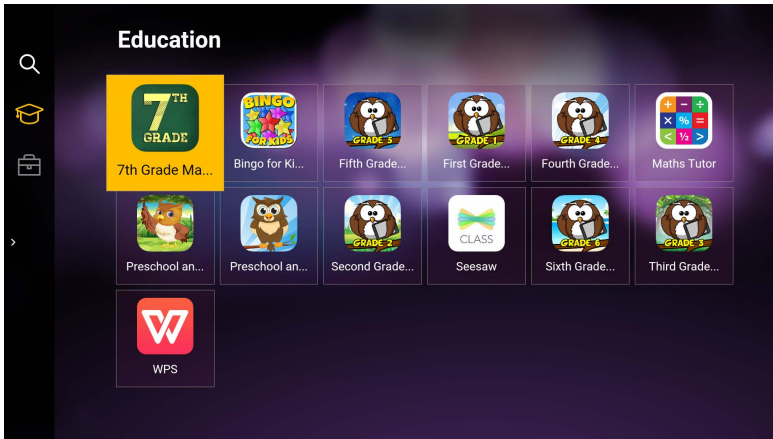

Tap the category on the left panel to browse the suggested apps. Tap an app from the selected category to view a basic description of the app.

Function	Description
<b>Search</b> (🔍)	Tap to search for an app.
<b>Education</b> (🎓)	Tap to show the suggested apps in the <b>Education</b> category.

<b>Corporation</b> (👤)	Tap to show the suggested apps in the <b>Corporation</b> category.
<b>Exit</b> (↩)	Tap to close <b>BenQ Suggests</b> .

## InstaShare

Tap  to launch **InstaShare**. With this application, you can mirror the display's screen on your smartphone or tablet for hands-on annotation and mirror the screen of your smartphone or tablet on the display.



Before launching the application, make sure your display is properly connected to Internet.

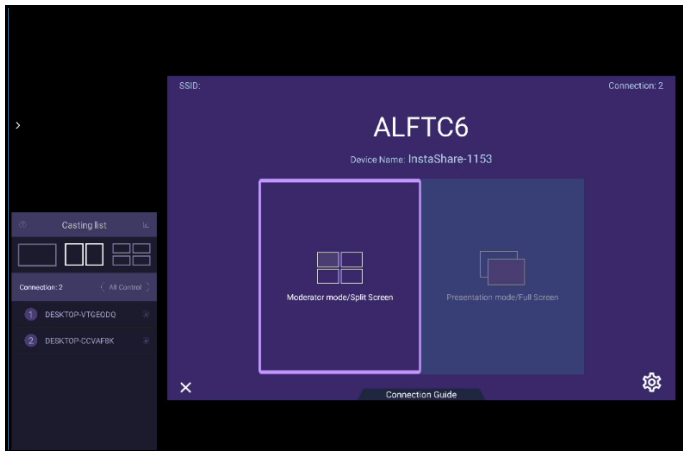

To use **InstaShare**:

1. Make sure your mobile device (such as smartphone or tablet) and the display are connected to the same network.
2. Press the connection guide and scan the QR code to download and install the **InstaShare** app on your mobile device.
3. Open the **InstaShare** app on your mobile device, and then click the **InstaShare** ID name that you want to connect to or enter the pairing code.
4. Enter the connect code shown on the upper right corner of the display or you can also find the connection code in **Setting** (⚙).
5. Once the mobile device has successfully connected to the display, a confirmation message will appear on the display. Tap **Allow** on the display to confirm the connection.
6. Once connected you can:
  - Mirror the display's screen on your mobile device by tapping **Screen Mirroring** on your mobile device.
  - Mirror the device's screen on the display by tapping  on your mobile device.

- Operate the display by using your mobile device as a remote control.



Once connected, any operations on the display or mobile device will also show up on your mobile device and display.

You can also tap **Setting** (⚙️) in the lower right corner of the display to modify the settings for **InstaShare**, such as the **InstaShare** ID name, connect code, or mirroring confirmation message.

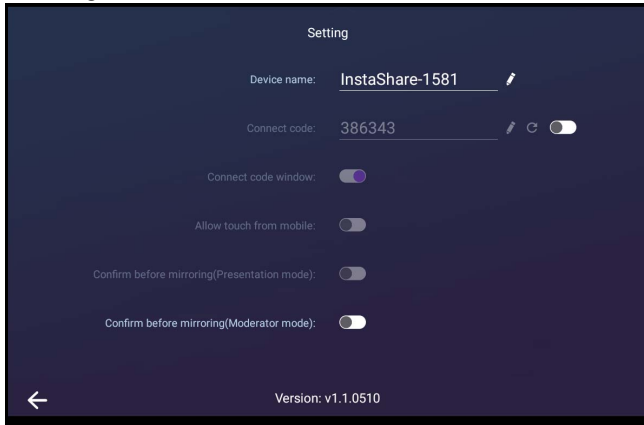

## InstaQPrint

Tap  to launch **InstaQPrint**. With this application, you can print a file or website image using a Wi-Fi or remote printer.



- Before launching the application, make sure your display is properly connected to Internet.
- For the list of supported printers, see [https://printhead.com/list\\_of\\_supported\\_printers.php](https://printhead.com/list_of_supported_printers.php).

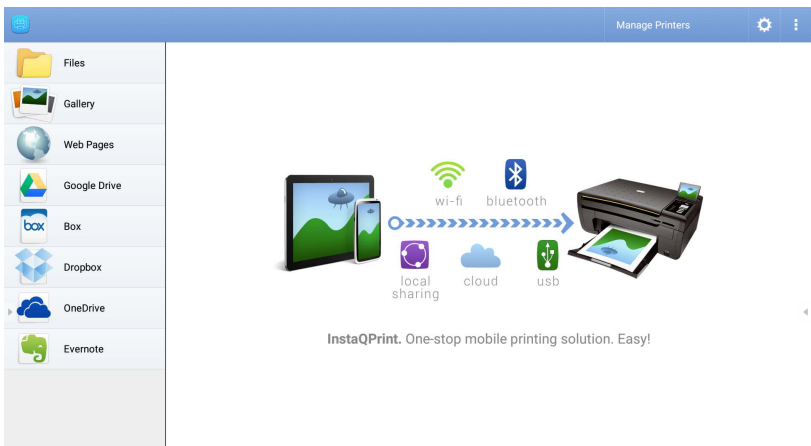

1. Tap the option on the left panel and browse and select the desired file, photo, page, or image you want to print.

2. Tap **Manage Printers** to choose which printer that you want to use.
3. To select a printer:
  - Tap an option from the list of available printers on the left panel.
  - Tap **Scan for Wi-Fi Printers** to search for printers automatically.
  - Tap **Manual Setup** to add a new printer manually.

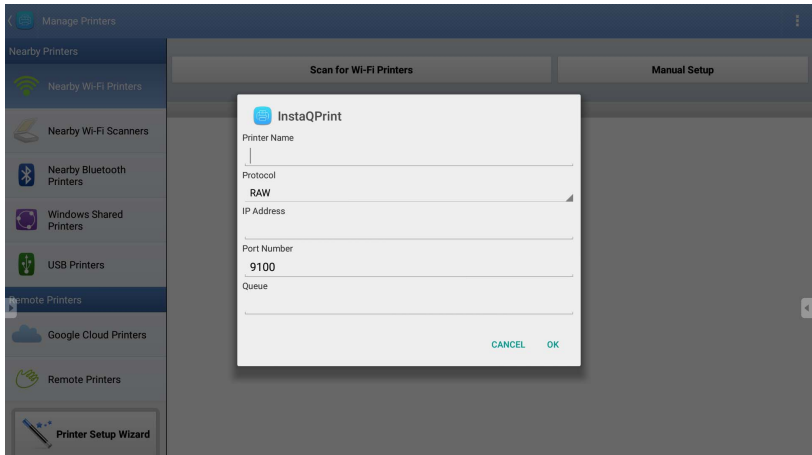

## WPS Office

Tap **W** to launch **WPS Office**. With this application, you can open document files including PDFs as well as Microsoft Word, PowerPoint and Excel documents.

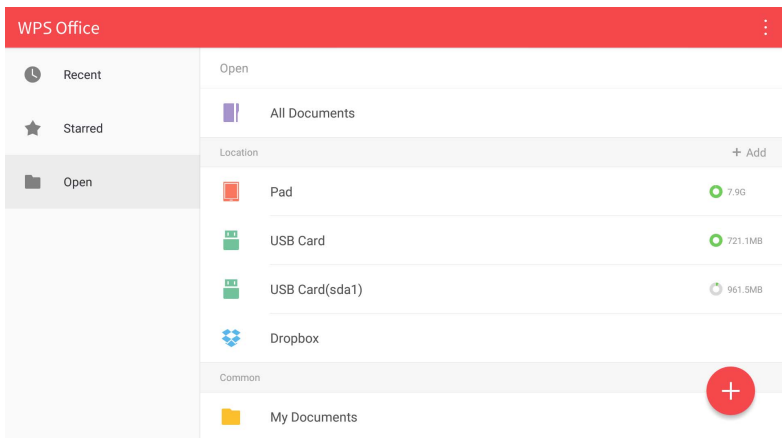

To edit a file with **WPS Office**:

1. Tap **Open** (  ) on the left panel to browse and open a file located in either the display's internal memory, an external storage device, or cloud storage.

2. Tap the function menu on the top panel to access the file format's various functions.



The description below is for a PowerPoint file, the function menus for other file formats will vary.

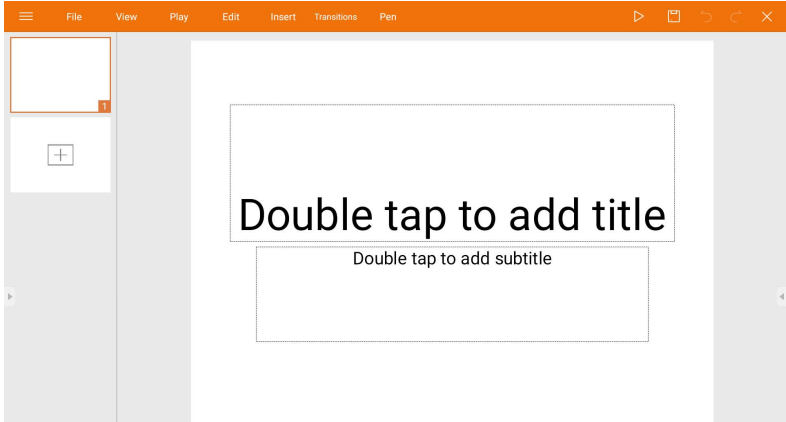

Function	Description
<b>File</b>	Tap to open, save, share, print, and manage your presentations.
<b>View</b>	Tap to change or edit the presentation views.
<b>Play</b>	Tap to start or set up a slide show.
<b>Edit</b>	Tap to edit the content or format of the slides.
<b>Insert</b>	Tap to insert tables, pictures, charts, comments, video, or audio.
<b>Transitions</b>	Tap to apply or adjust the timing of a transition.
<b>Pen</b>	Tap to write, draw, paint or sketch to the slides.
<b>Play (▷)</b>	Tap to start a slide show.
<b>Save As (📁)</b>	Tap to save the presentation file on either the display's internal memory, an external storage device, or cloud storage.
<b>Undo (↶)</b>	Tap to undo an action.
<b>Redo (↷)</b>	Tap to redo the last action.
<b>Close (✕)</b>	Tap to close the presentation file.
<b>Back (←)</b>	Tap to return to the previous page.
<b>Next (→)</b>	Tap to go to the next page.
<b>Exit (⏏)</b>	Tap to exit <b>WPS Office</b> .



## Supported Office versions and file formats

Supported Office versions: 97 / 2000 / XP / 2003 / 2007 / 2010 / 2013 / 2016

Supported Office software formats:

Office Software	Supported File Formats
Word	wps / wpt / doc / docx / dot / dotx / txt / log / irc / c / cpp / h / asm / s / java / asp / bat / bas / prg / cmd
Excel	et / ett / xls / xlsx / xlt / xltx / csv / xlsx / xltm
PowerPoint	ppt / pptx

## Email

- Tap  to launch **Email**.
- To use **Email**, set up an account first. Type your Email address and click **NEXT**.

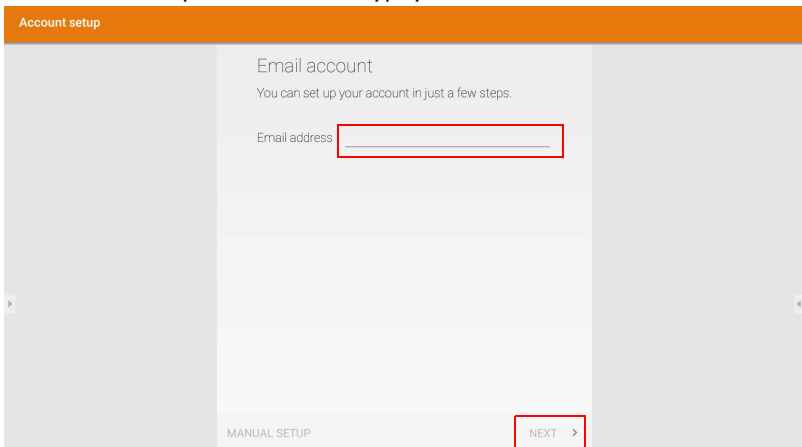

- After you've signed up, you will receive a verification email.
- After you respond to the Email verification, you can begin writing email.

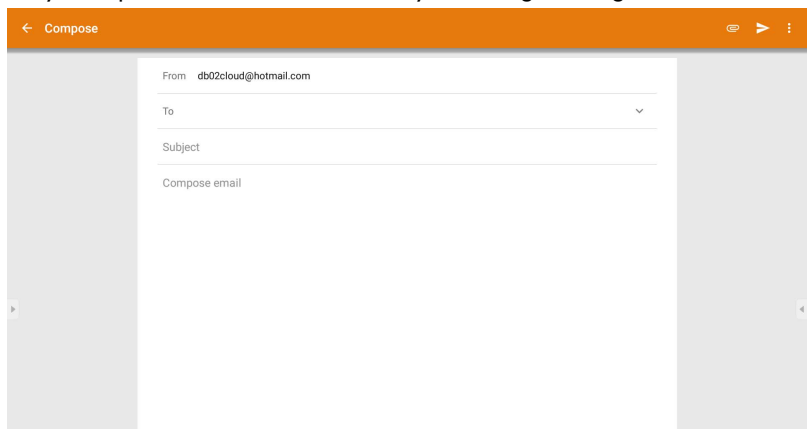

## Side Tool Bar



Function	Description
<b>Home</b> (🏠)	Tap to return to <b>Home</b> interface.
<b>Return</b> (↶)	Tap to return to previous operation interface.
<b>SwitchQ</b> (📄)	Tap to switch tasks between recent apps and input sources.
<b>Floating Annotation Toolbar</b> (📝)	Tap to open the floating tool.
<b>EZWrite 5.0</b> (EZ)	Tap to enter <b>EZWrite 5.0</b> software.

## Blizz

**Blizz** is a video-conferencing app that is installed in the display by default. It allows you to conveniently conduct video conference meetings with any other **Blizz** users.

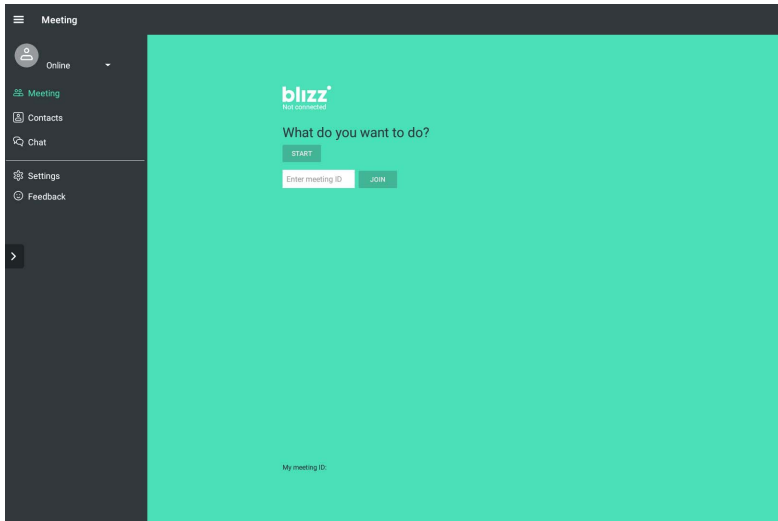

1. On the home screen, select **Apps >Blizz** 
2. Select **Sign In** if you want to create a new meeting, select **Join a Meeting** if you want to join an already created meeting.
  - After signing in, create a meeting ID which will be the meeting ID other users will enter to join the meeting.
  - If joining a meeting, enter the meeting ID provided by the creator of the meeting in the Join a Meeting page.

## Saffi

### How to start using Saffi – BenQ Voice Assistant

The BenQ Interactive Flat Panel offers an extra level of flexibility for device control through Voice Assistant. Voice Assistant lets users control the flow of meetings by allowing them to start timers or search the Internet from anywhere in the room.

### Already enable AMS service but did not bind your Amazon account to it

If you already enable Multi Account Mode and AMS service and you have not yet bind your Amazon account to it, please follow the below steps:

1. Access AMS website to link the account with Amazon. For more detail on how to link the account under AMS, please refer to AMS user manual.

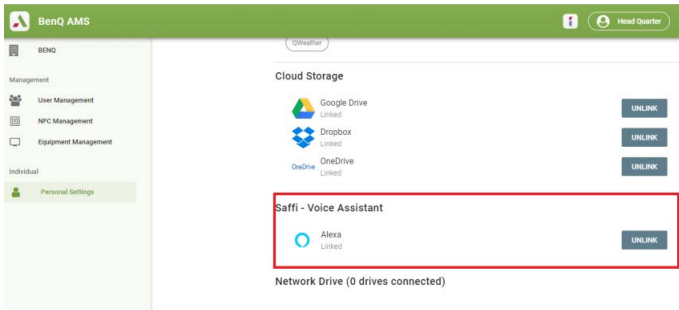

2. Press the Voice command key to activate Saffi.

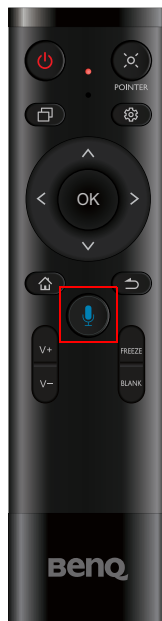

- The screen will show the privacy agreement. Select **AGREE AND NEXT** to proceed.

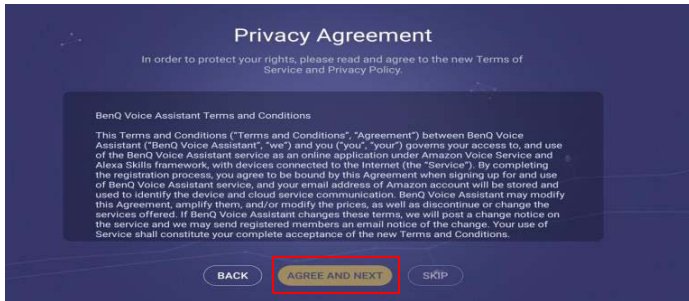

- It will then show the instruction for the setup. Follow the instruction on the screen to complete the setup.

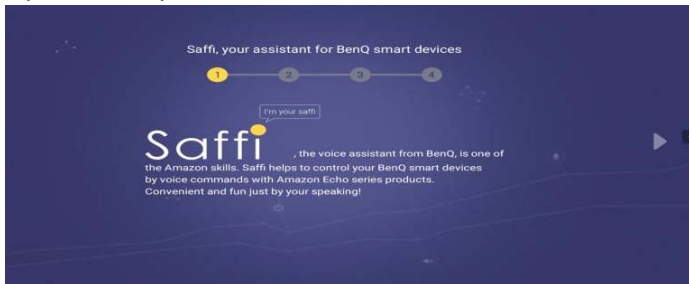

- Download and install Alexa app on your phone. Search Saffi and enable it.

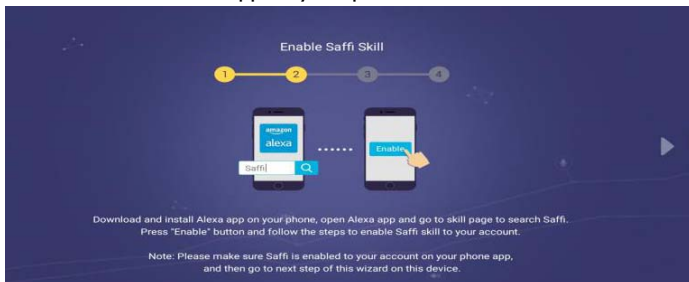

- The setup is completed. Press the Voice command key and speak the commands to start using Saffi.

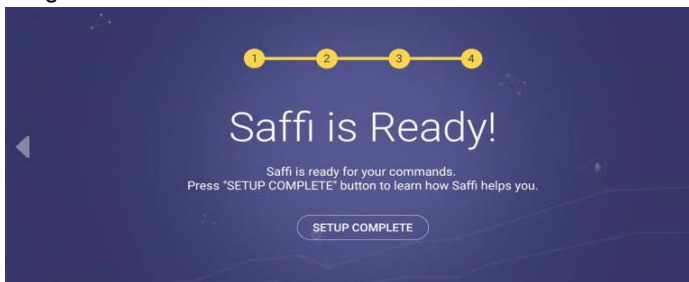

# Product information

## Specifications

Item	Specifications	
	RP6502 / RP7502 / RP8602	
LCD panel	Light source	DLED
	Panel size	RP6502: 65", RP7502: 75", RP8602: 86"
	Pixel pitch (mm)	RP6502: 0.372 (H) x 0.372 (V) RP7502: 0.43 (H) x 0.43 (V) RP8602: 0.4935 (H) x 0.4935 (V)
	Native resolution (pixels)	3840 x 2160
	Brightness (cd/m <sup>2</sup> ) (typical)	RP6502: 350 (typ) RP7502: 450 (typ) RP8602: 400 (typ)
	Contrast ratio (typical)	1200:1
	Response time (ms) (typical)	8 (typ)
	Panel Bit	RP6502/RP7502: 10 bits (8 bits+FRC) RP8602: 10 bits
Touch	Technology	IR
	Touch Method	Finger & Stylus (with NFC x2)
	Resolution	32767 x 32767
	Capacity	20 points (HW spec)/ 10 points (Android) (varies from operating systems and applications)
	Accuracy	+/- 1mm over 90% of touchable area
	Touch Output	Rear: x2 (USB type B), Front: x1 (USB type B)
	OS Supported	Ubuntu 14.04 or above, windows 7/8/8.1/10, Mac OS X 10.12 or above, Chrome 54 or above, Android 4.0 or above
	OS for Touch Driver Free	Ubuntu, Windows 7/8/8.1/10, Mac OS X 10.12 or above, Android 4.0 or above
Panel glass	Tempered glass	AG 80 Coating
	Thickness (mm)	4mm, 9H
Input	Computer	VGA IN x 1
	Video	HDMI IN 2.0 x 3, HDMI OUT (4K support) x 1
	Audio	Line-in (3.5 mm) x 1 MIC
	USB	USB (type A) x 5 USB (type B) x 3 USB (type C) x 1
	Control	RS-232 x 1
	TV Tuner	NO

Output	Computer	NO
	Video	NO
	Audio	Line out (3.5mm) x 1
	External speaker out (L/R)	NO
Audio	Audio W (Amp)	16W Studio speaker x 2 15W subwoofer x 1
	Microphone	x 8
Power	Supply	RP6502: 3.5A RP7502: 5.0A RP8602: 5.5A 100 - 240V AC, 50/60 Hz
	Consumption Max.	RP6502: 202.1W RP7502: 374.9W RP8602: 423.1W
	Consumption Standby	< 0.5W
	Wake Up	HDMI, VGA, LAN
	Operating Temperature	0 - 40°C
Environment	Operating Humidity	20 - 80% (without condensation)
	Storage Temperature	-10 - 60°C
	Storage Humidity	10 - 60% (without condensation)
	Display Orientation	Landscape Only
	Weight (kg)	RP6502: 44kg RP7502: 61kg RP8602: 79kg
Mechanical	Dimensions (W x H x D) (mm)	RP6502: 1505.9 x 951.0 x 121.5 RP7502: 1735.5 x 1085.8 x 130.7 RP8602: 1988.8 x 1229.8 x 138.4
	Bezel Dimension - T/B/ L/R (mm)	23.4 / 23.4 / 23.4 / 23.4

Feature	Image setting	YES
	Source/Volume Control	YES
	Sharpness enhancement	YES
	Anti image retention	YES
	Motion sensor	YES
	Ambient light sensor	YES
	10-bit color processing	YES
	Customized Classroom Mode	YES
Blank screen	YES	



Specifications and functions are subject to change without notice.

Item		RP6502 / RP7502 / RP8602
System	CPU	Dual core A73+Dual core A53/1.5GHz
	System Memory	4GB
	Storage	32GB
	OS	Android 8.0



This Android 6.0 operating system is not standard Android, so access to Google Play™ is not available. APK cannot be installed in the default location unless given permission by the management units. Contact your BenQ dealer for the required support for management permission. Without management permission, installing function won't work. There is no guarantee that the self-installed APK can function normally.



# Dimensions (RP6502)

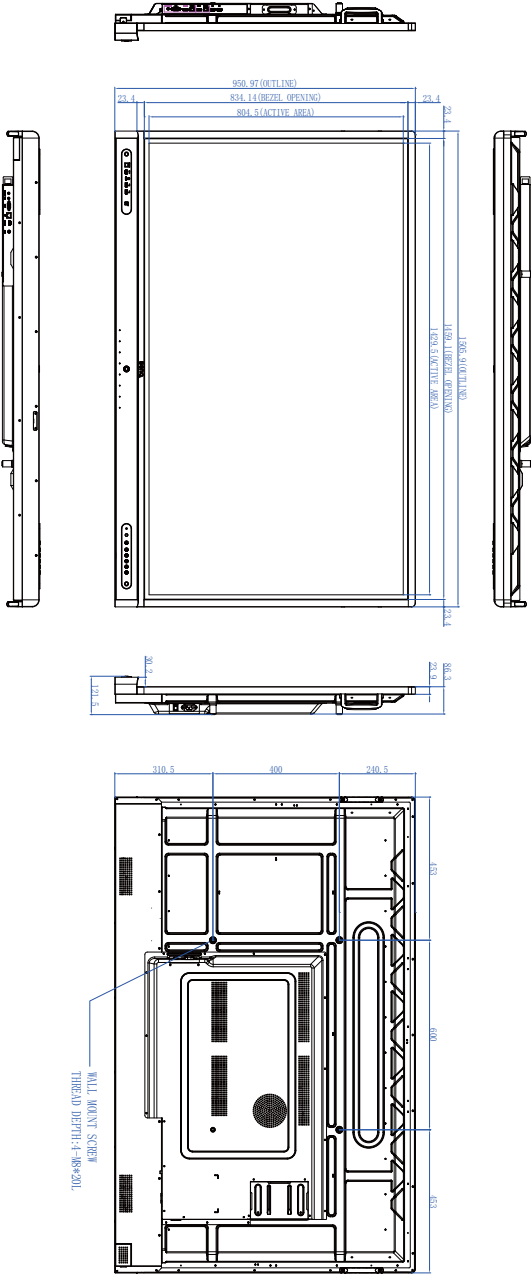

Unit: mm

# Dimensions (RP7502)

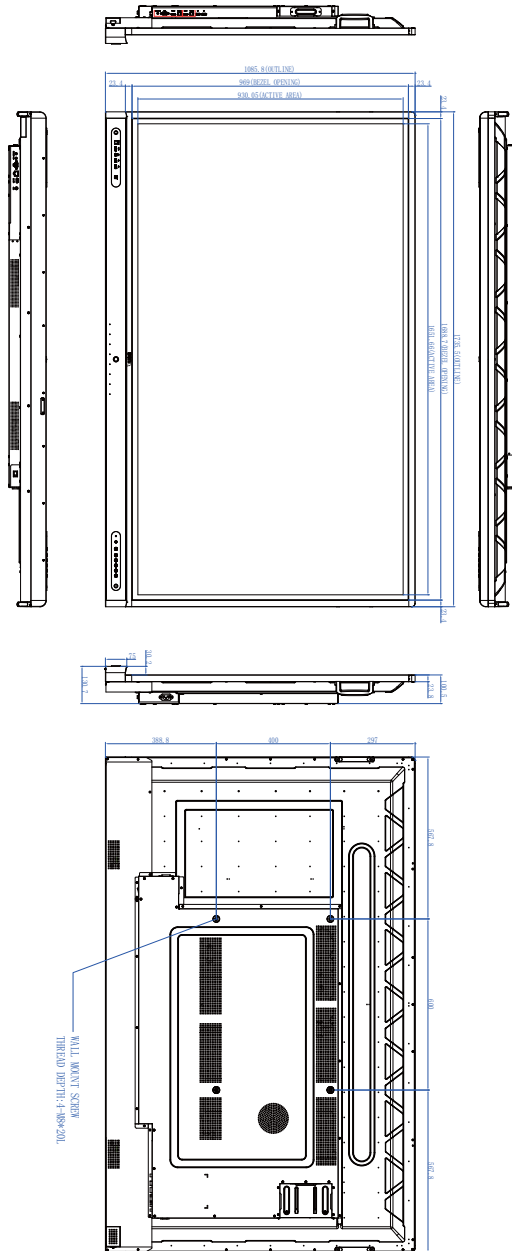

Unit: mm

# Dimensions (RP8602)

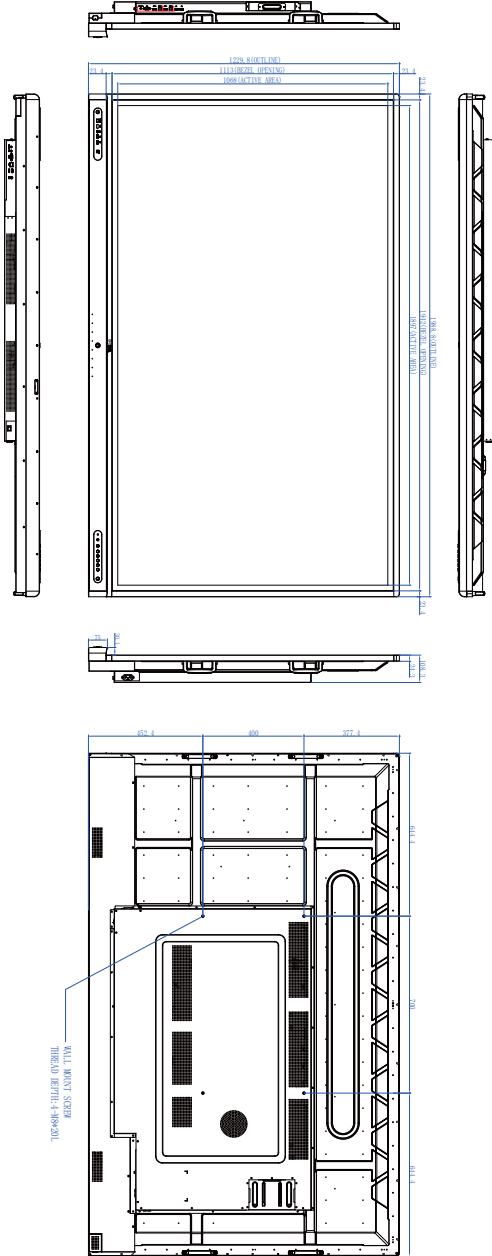

Unit: mm

## Supported input signal resolution

Resolution	Input source		
	TYPE C	VGA	HDMI 2.0
640 x 480 @ 60Hz		○	
720 x 400 @ 85Hz		○	
800 x 600 @ 60Hz	○	○	○
1024 x 768 @ 60Hz	○	○	○
1280 x 768 @ 60Hz	○	○	○
1280 x 960 @ 60Hz	○	○	○
1280 x 1024 @ 60Hz	○	○	○
1366 x 768 @ 60Hz	○	○	○
1440 x 900 @ 60Hz	○	○	○
1680 x 1050 @ 60Hz	○	○	○
1920 x 1080 @ 60Hz	○	○	○
3840 x 2160 @ 24Hz			○
3840 x 2160 @ 25Hz			○
3840 x 2160 @ 30Hz			○
3840 x 2160 @ 50Hz			○
3840 x 2160 @ 60Hz	○		○
480i (60Hz)			○
480p (60Hz)	○		○
576i (50Hz)			○
576p (50Hz)	○		○
720p (50Hz)			○
720p (60Hz)	○		○
1080i (50Hz)			○
1080i (60Hz)			○
1080p (50Hz)			○
1080p (60Hz)	○		○



- : supported
- Vacant: not supported

## Troubleshooting

Problem	Solution
No picture	<p>Check the following:</p> <ul style="list-style-type: none"> <li>• Is the display turned on? Check the power indicator of the display.</li> <li>• Is the signal source device turned on? Turn on the device and try again.</li> <li>• Are there any loose cable connections? Make sure that all cables are connected firmly.</li> <li>• Have you chosen an unsupported output resolution on the computer? Refer to <a href="#">Supported input signal resolution on page 76</a> to select a supported resolution and try again.</li> <li>• Have you chosen an unsupported output resolution on the DVD or Blu-ray disc player? Refer to <a href="#">Supported input signal resolution on page 76</a> to select a supported resolution and try again.</li> </ul>
No sound	<p>Check the following:</p> <ul style="list-style-type: none"> <li>• Have you turned on the mute function on the display or the input source device? Turn off the mute function or increase the audio volume level and try again.</li> <li>• Are there any loose cable connections? Make sure that all cables are connected firmly.</li> </ul>
The computer input image looks strange	<ul style="list-style-type: none"> <li>• Have you chosen an unsupported output resolution on the computer? Refer to <a href="#">Supported input signal resolution on page 76</a> to select a supported resolution and try again.</li> <li>• Use the <b>Auto</b> function (VGA only) to let the display automatically optimize the display of computer image.</li> <li>• If the result of the <b>Auto</b> function is not satisfactory, use the <b>Phase</b>, <b>H Position</b> and <b>V Position</b> functions to manually adjust the image.</li> </ul>
The control panel buttons do not work	<p>Have you locked the control panel buttons? Unlock the buttons and try again.</p>

The remote control does not work	<ul style="list-style-type: none"> <li>• Have you locked the remote control function? Unlock the function and try again.</li> <li>• Check for incorrect battery orientation.</li> <li>• Check for dead batteries.</li> <li>• Check your distance and angle from the display.</li> <li>• Check whether remote control is properly being pointed at the display's remote control sensor window.</li> <li>• Check for any obstacle between the remote control and the remote control sensor window.</li> <li>• Check that the remote control sensor window is not under strong fluorescent lighting, or in direct sunlight.</li> <li>• Check for any devices (computer or personal digital assistant, PDA) nearby that transmit infrared signals which may cause interference to signal transmission between the remote control and the display. Turn off the infrared function of these devices.</li> </ul>
Remote control failure	<ul style="list-style-type: none"> <li>• Check whether there are other objects between remote control and television remote control receiving window, thus leading to failure of remote control.</li> <li>• Check whether the battery electrode in the remote control is correct.</li> <li>• Check whether remote control needs to replace battery.</li> </ul>
Machine automatically shutdown	<ul style="list-style-type: none"> <li>• Whether set sleep or not.</li> <li>• Check whether there is sudden power outage.</li> <li>• Check whether there is no signal automatic shutdown.</li> </ul>
Signal out of range	<ul style="list-style-type: none"> <li>• Check whether display is set correctly.</li> <li>• Check whether resolution is the best resolution.</li> <li>• Adjust line and field synchronization in menu.</li> </ul>
Background has vertical lines or streaks	<ul style="list-style-type: none"> <li>• Select automatic correction in menu.</li> <li>• Adjust clock and phase position in menu.</li> </ul>
Image lack of color, color is incorrect	<ul style="list-style-type: none"> <li>• Check whether VGA is not well connected or has quality problem.</li> <li>• Adjust chromaticity and brightness or contrast in menu.</li> </ul>
Display format that is not supported.	<ul style="list-style-type: none"> <li>• Select automatic correction in menu.</li> <li>• Adjust clock and phase position in menu.</li> </ul>
Touch function invalid	<ul style="list-style-type: none"> <li>• Check whether touch driver is installed and started.</li> <li>• Check whether the size of article touched is comparable with finger.</li> </ul>
Touch positioning not correct	<ul style="list-style-type: none"> <li>• Check whether driver is properly installed and make correction.</li> <li>• Check whether touch pen is facing the screen.</li> </ul>

No picture and no sound	<ul style="list-style-type: none"> <li>• Check whether the machine is started state.</li> <li>• Check whether signal wire is well plugged, whether INPUT is corresponding to it.</li> <li>• If in internal computer mode, check whether internal computer is started.</li> </ul>
With horizontal or vertical stripes or image dithering	<ul style="list-style-type: none"> <li>• Check whether signal wire is well connected.</li> <li>• Check whether other electronic equipment or power tools are placed around the machine.</li> </ul>
No color, color is weak or image is weak	<ul style="list-style-type: none"> <li>• Adjust chromaticity and brightness or contrast in menu.</li> <li>• Check whether signal wire is well connected.</li> </ul>
With image but without sound	<ul style="list-style-type: none"> <li>• Check whether mute button is pressed for mute.</li> <li>• Press <b>VOL+/VOL-</b> to adjust volume.</li> <li>• Check whether audio line is connected correctly.</li> </ul>
Only one speaker has sound	<ul style="list-style-type: none"> <li>• Adjust sound balance in menu.</li> <li>• Check whether computer sound control panel only sets up one sound channel.</li> <li>• Check whether audio line is connected correctly.</li> </ul>
VGA output without sound	Check whether connect external device with headphone cable.

## Accessibility Requirements for Rehabilitation Act of 1973, Section 508

BenQ's commitment to accessible products allows us to support government in making accessible technology choices. BenQ's displays are compliant with Section 508 guidelines by including the assistive features as below:

- BenQ's displays have colored "Power" indicators. Refer to the user manual for color definitions. While the display is in standby or sleep mode for wake-up function, it uses less than two watts of electricity.
- BenQ's displays have a variety of settings of pre-programmed flicker-free timing to make the screen shown on the display readily accessible. The default timing setting is automatically turned on every time the displays is powered up, and thus reduces the hassle of user intervention.
- BenQ's displays have options for brightness and contrast adjustments that text and images could be displayed differently to meet the demands of the visually impaired. Other similar adjustments are also available by using the On-Screen Display (OSD) controls on the products.
- BenQ's displays include user-selectable color controls, such as color temperature selections ( IFP: 5500K, 9300K, 12000K, DS: 6500K, 9300K, 12000K), with a wide range of contrast levels.
- BenQ's multimedia displays usually have one or two speakers for audio performance which allow users (including hearing impaired) to interact with the computer systems connected. Speaker controls are typically located on the front-panel.
- Firmware of BenQ's displays contain unique product information that helps computer systems to identify BenQ products and activate their Plug-and-Play function when connected.
- All BenQ's displays are compatible with the PC99 standard. For example, connectors are colorcoded to help users easily connecting products to computer systems correctly.
- Some models of BenQ's displays contain additional USB ports for connection to more devices such as a special headphone to assist the hearing impaired.
- All BenQ displays come with user manuals, which are available on the BenQ's web site ([www.BenQ.com](http://www.BenQ.com)). Other types of documents may be available upon requests.
- BenQ's customer service provides answers and assistance to all our customers through phone calls, facsimiles, e-mails, or web sites.